



NATURAL HARDWOOD FURNITURE
MADE IN VERMONT

bedroom

dining

living room

home office

About Copeland

Copeland Furniture has been producing wood products and furniture since 1976. We have gradually grown over the years from a one man shop to the largest employer in our small town of Bradford, Vermont producing high quality furniture.

We are surrounded by beauty. The architectural gems that line the streets in Vermont's well preserved villages inform our aesthetic and sense of proportion. The natural landscape surrounds us with beauty in the form of farmland and mountains, and is also the source of a renewable resource - solid hardwood - from which we build beautiful furniture for your home.

We know that our environment is, in many ways, very fragile. We are the beneficiaries of the strong stewardship ethic practiced and passed down by those who went before us. We hope that the next generation appreciates our stewardship and is inspired to continue the tradition.

We hope that you can see that respect for the landscape in the furniture we build for your home – timeless designs and timeless quality.

We remain a family owned and operated business committed to manufacturing high quality products in America.



Tim Copeland, Copeland Furniture





BEDROOM



astrid bedroom in cherry

With its deeply splayed legs producing dramatic cantilevers, the Astrid Bedroom is an engineering feat that defies expectations and inspires a sense of possibility. A true platform bed, Astrid may be ordered with or without the headboard panels. Recommended mattress thickness is 8" to 12".

The Astrid Bedroom is crafted in solid cherry hardwood and Made to Order in six finishes* (specify conventional or water borne finish) with a variety of knob or pull options.

*Natural variations in solid wood and hand-applied finishes make each piece unique. Slight grain and irregularities as well as subtle differences in stain shades are signs that the furniture has been crafted from solid wood and are considered hallmarks of quality.



astrid bed - with 2 headboard panels

		w	l	h
queen	1-AST-12-03	66"	87 1/2"	40" or 44"
king	1-AST-11-03	82"	87 1/2"	40" or 44"
cal king	1-AST-15-03	78"	91 1/2"	40" or 44"
1 drawer	2-AST-10-03	18 1/2"	18"	20 3/8"



astrid bed - with 1 headboard panel

		w	l	h
queen	1-AST-22-03	66"	87 1/2"	36" or 39"
king	1-AST-21-03	82"	87 1/2"	36" or 39"
cal king	1-AST-25-03	78"	91 1/2"	36" or 39"
shelf nightstand left or right	2-AST-01-03	13"	15"	1 1/2"H



astrid bed - without headboard panels

		w	l	h
queen	1-AST-02-03	66"	86"	14 1/4"
king	1-AST-01-03	82"	86"	14 1/4"
cal king	1-AST-05-03	78"	90"	14 1/4"

6 drawer



2-AST-60-03
66" x 18" x 31 3/8"H

3 drawer + tv organizer



2-AST-35-03
33 1/2" x 18" x 37 1/2"H

laptop desk



3-AST-20-03
33 1/2" x 18" x 37 1/2"H

5 drawer



2-AST-50-03
26 7/8" x 18" x 51 1/2"H

3 drawer



2-AST-30-03
33 1/2" x 18" x 31 3/8"H

4 drawer



2-AST-40-03
33 1/2" x 18" x 37 1/2"H

wall mirror



5-MAN-21-03
30"W x 28 3/4"H x 1 1/4"Deep

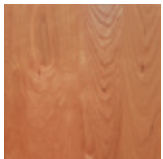

natural cherry (03)

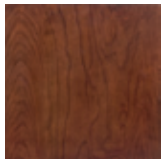

windsor cherry (13)



autumn cherry (23)

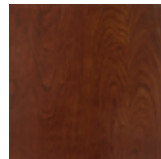

cognac cherry (33)



saddle cherry (43)

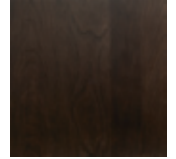

smoke cherry (53)



astrid bed - with 2 headboard panels

		w	l	h
queen	1-AST-12-01	66" x 87 1/2" x 40" or 44"		
king	1-AST-11-01	82" x 87 1/2" x 40" or 44"		
cal king	1-AST-15-01	78" x 91 1/2" x 40" or 44"		
1 drawer	2-AST-10-01	18 1/2" x 18" x 20 3/8"		

astrid bedroom in maple

With its deeply splayed legs producing dramatic cantilevers, the Astrid Bedroom is an engineering feat that defies expectations and inspires a sense of possibility. A true platform bed, Astrid may be ordered with or without the headboard panels. Recommended mattress thickness is 8" to 12".

The Astrid Bedroom is crafted in solid maple hardwood and Made to Order in five finishes* (specify conventional or water borne finish) with a variety of knob or pull options.

*Natural variations in solid wood and hand-applied finishes make each piece unique. Slight grain and irregularities as well as subtle differences in stain shades are signs that the furniture has been crafted from solid wood and are considered hallmarks of quality.



astrid bed - with 1 headboard panel

		w	l	h
queen	1-AST-22-01	66" x 87 1/2" x 36" or 39"		
king	1-AST-21-01	82" x 87 1/2" x 36" or 39"		
cal king	1-AST-25-01	78" x 91 1/2" x 36" or 39"		
shelf nightstand left or right	2-AST-01-01	13" x 15" x 1 1/2"H		



astrid bed - without headboard panels

		w	l	h
queen	1-AST-02-01	66" x 86" x 14 1/4"		
king	1-AST-01-01	82" x 86" x 14 1/4"		
cal king	1-AST-05-01	78" x 90" x 14 1/4"		

wall mirror



5-CAL-20-01
30"W x 28 3/4"H x 1 1/4"Deep

3 drawer + tv organizer



2-AST-35-01
33 1/2" x 18" x 37 1/2"H

5 drawer



2-AST-50-01
26 7/8" x 18" x 51 1/2"H

3 drawer



2-AST-30-01
33 1/2" x 18" x 31 3/8"H

4 drawer



2-AST-40-01
33 1/2" x 18" x 37 1/2"H

laptop desk



3-AST-20-01
33 1/2" x 18" x 37 1/2"H

6 drawer



2-AST-60-01
66" x 18" x 31 3/8"H



natural maple (01)

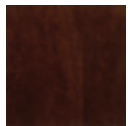

cocoa maple (11)



dark chocolate
maple (21)

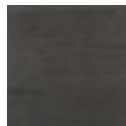

slate maple (41)



white maple (51)



dark honey maple
(61)



chestnut maple (71)



black maple (81)



astrid bedroom in walnut and dark chocolate maple

With its deeply splayed legs producing dramatic cantilevers, the Astrid Bedroom is an engineering feat that defies expectations and inspires a sense of possibility. A true platform bed, Astrid may be ordered with or without the headboard panels. Recommended mattress thickness is 8" to 12". The collection is crafted in solid walnut and dark chocolate finish on solid maple hardwood and is Made to Order with a variety of knob or pull options. Specify conventional or water borne finish.



astrid bed - with 2 headboard panels

		w	l	h
queen	1-AST-12-14	66" x 87 1/2" x 40" or 44"		
king	1-AST-11-14	82" x 87 1/2" x 40" or 44"		
cal king	1-AST-15-14	78" x 91 1/2" x 40" or 44"		
1 drawer	2-AST-10-14	18 1/2" x 18" x 20 3/8"		



astrid bed - with 1 headboard panel

		w	l	h
queen	1-AST-22-14	66" x 87 1/2" x 36" or 39"		
king	1-AST-21-14	82" x 87 1/2" x 36" or 39"		
cal king	1-AST-25-14	78" x 91 1/2" x 36" or 39"		
shelf nightstand left or right	2-AST-01-04	13" x 15" x 1 1/2"H		



astrid bed - without headboard panels

		w	l	h
queen	1-AST-02-14	66"	86"	14 1/4"
king	1-AST-01-14	82"	86"	14 1/4"
cal king	1-AST-05-14	78"	90"	14 1/4"

6 drawer



2-AST-60-14
66" x 18" x 31 3/8"H

3 drawer + tv organizer



2-AST-35-14
33 1/2" x 18" x 37 1/2"H

laptop desk



3-AST-20-14
33 1/2" x 18" x 37 1/2"H

5 drawer



2-AST-50-14
26 7/8" x 18" x 51 1/2"H

3 drawer



2-AST-30-14
33 1/2" x 18" x 31 3/8"H

4 drawer



2-AST-40-14
33 1/2" x 18" x 37 1/2"H

wall mirror



5-CAL-20-04
30"W x 28 3/4"H x 1 1/4"Deep



berkeley bedroom

A fusion of Arts & Crafts and Asian design, the Berkeley Bedroom is both sophisticated and practical. Crafted in solid cherry hardwood* with American black walnut accents, the collection features a variety of cases and a low footboard bed designed for use with a mattress only. The Berkeley Bedroom is Made to Order in six finishes** (specify conventional or water borne finish) with a variety of pull options.

*Case sides are laminated with cherry veneer.

**Natural variations in solid wood and hand-applied finishes make each piece unique. Slight grain and irregularities as well as subtle differences in stain shades are signs that the furniture has been crafted from solid wood and are considered hallmarks of quality.



berkeley bed with storage

		w	l	h
full	1-BER-13-03-STOR	58 1/4"	79"	52"
queen	1-BER-12-03-STOR	64 1/4"	84"	52"
king	1-BER-11-03-STOR	80 1/4"	84"	52"
cal king	1-BER-15-03-STOR	76 1/4"	88"	52"



Space, style and function are the three main themes expressed in the Berkeley storage bed. With 4, eight inch deep, sub-mounted drawers, the bed provides plenty of inconspicuous storage, allowing for a roomier living environment. The Berkeley storage bed is unique, in that the drawers are mounted six inches above the floor allowing for easier access than other storage beds. The Berkeley bed is crafted in solid cherry hardwood with American black walnut accents.

The optional nightstands, also crafted in solid cherry are designed to allow easy access to the storage drawers.

All pieces are Made to Order in six finishes** (specify conventional or water borne finish) with a variety of knob or pull options.



berkeley bed

full
queen
king
cal king

2 drawer

	w	l	h
1-BER-13-03	58 1/4"	79"	52"
1-BER-12-03	64 1/4"	84"	52"
1-BER-11-03	80 1/4"	84"	52"
1-BER-15-03	76 1/4"	88"	52"
2-BER-20-03	23 3/4"	22"	25 1/2"

nighstand - left



2-BER-01-03
22" x 15 1/2" x 26"H

nighstand - right



2-BER-02-03
22" x 15 1/2" x 26"H

1 drawer



2-BER-11-03
21 3/4" x 20" x 25 1/2"H

2 drawer + tv organizer



2-BER-25-03
33 3/4" x 20 1/4" x 35 1/4"H

4 drawer chest + tv organizer



2-BER-45-03
33 3/4" x 20 1/4" x 50"H

4 drawer dresser + tv organizer



2-BER-46-03
58 3/4" x 20 1/4" x 35 1/4"H



natural cherry (03)

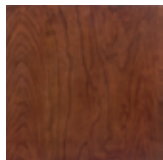

windsor cherry (13)



autumn cherry (23)

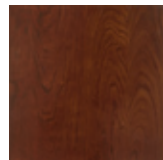

cognac cherry (33)

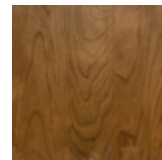

saddle cherry (43)

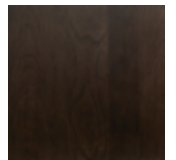

smoke cherry (53)

3 drawer



2-BER-30-03
33 3/4" x 20 1/4" x 35 1/4"H

5 drawer



2-BER-50-03
33 3/4" x 20 1/4" x 50"H

6 drawer & accessory case



2-BER-60-03
58 3/4" x 20 1/4" x 35 1/4"H
5-BER-10-03
49 3/4" x 16" x 6 1/4"

wall mirror



5-BER-21-03
52"W x 34 1/4"H x 3"Deep

10 drawer



2-BER-80-03
58 3/4" x 20 1/4" x 50"H

floor mirror



5-BER-30-03
25 1/4" x 19 1/2" x 64"H

8 drawer + tv organizer



2-BER-85-03
58 3/4" x 20 1/4" x 50"H

bench upholstery options

Upholstered items are available in a range of microsuede, fabric or leather colors as well as COM (customer's own material). Please refer to the upholstery page of this catalog.

bench



5-BER-60-03
58" x 19" x 19"H

7 drawer



2-BER-70-03
23 3/4" x 22" x 61"H



catalina bedroom

Combining the clean, unadorned lines of the International Modernists with organic and geometric forms, the Catalina Collection is suggestive of the works of America's Mid-Century Modern designers. The years following WWII were a time of uncertainty but also of great hope and progress. Designs of the period reflected that sense of hope and the promise of an ideal future. In our current period, one finds comfort and nostalgia in Catalina's retro-modern shapes and sensibilities.

The Catalina bed is low and sleek, designed for a mattress only, and is available in two heights. It is perfectly complemented by a selection of case pieces, including a 3 drawer chest with organizer options for home entertainment equipment and a laptop desk that creates a trim, functional workspace.

The Catalina Bedroom is crafted in solid American black walnut hardwood* with natural finish (specify conventional or water borne finish) and Made to Order with a variety of knob or pull options.

*Bed headboard panel is laminated with walnut veneer.



catalina bed - 40"H headboard

		w	l	h
queen	1-CAL-12-04	66 1/2"	88 3/4"	40"
king	1-CAL-11-04	82 1/2"	88 3/4"	40"
cal king	1-CAL-15-04	78 1/2"	92 3/8"	40"



catalina bed - 37"H headboard

		w	l	h
queen	1-CAL-02-04	66 1/2"	86 5/8"	37"
king	1-CAL-01-04	82 1/2"	86 5/8"	37"
cal king	1-CAL-05-04	78 1/2"	90 5/8"	37"

nightstand



2-CAL-15-04
20" x 20" x 17 1/4"H

2-CAL-25-04
20" x 20" x 20 1/4"H

1 drawer



2-CAL-10-04
18 1/2" x 18" x 22"H

wall mirror



5-CAL-20-04
30"W x 28 3/4"H x 1 1/4"Deep

3 drawer



2-CAL-30-04
33 1/2" x 18" x 29 7/8"H

3 drawer + tv organizer



2-CAL-35-04
33 1/2" x 18" x 36"H

4 drawer



2-CAL-40-04
33 1/2" x 18" x 36"H

5 drawer



2-CAL-50-04
26 7/8" x 18" x 50"H

laptop desk



3-CAL-20-04
33 1/2" x 18" x 36"H

4 drawers on left, 1 drawer over 2 doors on right dresser



2-CAL-72-04
66 1/8" x 18" x 36"H

4 drawer on right, 1 drawer over 2 doors on left dresser



2-CAL-71-04
66 1/8" x 18" x 36"H

3 drawers on left, 2 doors on right dresser



2-CAL-52-04
66 1/8" x 18" x 29 7/8"H

3 drawers on right, 2 doors on left dresser



2-CAL-51-04
66 1/8" x 18" x 29 7/8"H

6 drawer



2-CAL-60-04
66 1/8" x 18" x 29 7/8"H

8 drawer



2-CAL-80-04
66 1/8" x 18" x 36"H

contour bed - with left and right shelf nightstands

		w	l	h
queen	1-CTR-32-04	94"	87 1/2"	41 1/2"
king	1-CTR-31-04	110"	87 1/2"	41 1/2"
cal king	1-CTR-35-04	106"	91 1/2"	41 1/2"



contour bedroom

With a continuous ribbon of solid walnut surrounding the mattress and wrapping up and around the headboard, the Contour bed exemplifies streamline Modernism. The sleek Contour cases feature softened corners with shaped Opel laminated glass tops. The Contour bed is designed for a mattress only. It is perfectly complemented by attached shelf nightstands.

The Contour Bedroom is crafted in solid American black walnut hardwood with natural finish (specify conventional or water borne finish) and Made to Order with a variety of knob or pull options.



contour bed - with left shelf nightstand

		w	l	h
queen	1-CTR-12-04	78"	87 1/2"	41 1/2"
king	1-CTR-11-04	94"	87 1/2"	41 1/2"
cal king	1-CTR-15-04	90"	91 1/2"	41 1/2"



contour bed - with right shelf nightstand

		w	l	h
queen	1-CTR-22-04	78"	87 1/2"	41 1/2"
king	1-CTR-21-04	94"	87 1/2"	41 1/2"
cal king	1-CTR-25-04	90"	91 1/2"	41 1/2"



contour bed

queen
king
cal king

	w	l	h
1-CTR-02-04	62"	87 1/2"	41 1/2"
1-CTR-01-04	78"	87 1/2"	41 1/2"
1-CTR-05-04	74"	91 1/2"	41 1/2"

1 drawer



2-CTR-10-04
20" x 18" x 22"H

3 drawer



2-CTR-30-04
35" x 18" x 30 7/8"H

3 drawer + tv organizer



2-CTR-35-04
35" x 18" x 36 7/8"H

4 drawer



2-CTR-40-04
35" x 18" x 36 7/8"H

laptop desk



3-CTR-20-04
35" x 18" x 36 7/8"H

5 drawer



2-CTR-50-04
28 3/8" x 18" x 50 7/8"H

6 drawer



2-CTR-60-04
67 5/8" x 18" x 30 7/8"H

8 drawer



2-CTR-80-04
67 5/8" x 18" x 36 7/8"H



made in america
made to order
made to last



THE DOMINION COLLECTION

copeland
FURNITURE

copelandfurniture.com

THE DOMINION BEDROOM

Five Unique Headboard Designs



Cambridge Leather Panel
(1-CAM)



Concord 2 Panel
(1-CON)



Chatham Slat
(1-CHA)



Canaan Spindle
(1-CAN)



Coventry Panel
(1-COV)

Finish Options



natural cherry (03)

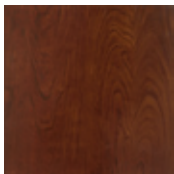

cognac cherry (33)



saddle cherry (43)

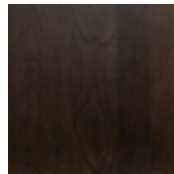

smoke cherry (53)

Hardware Options

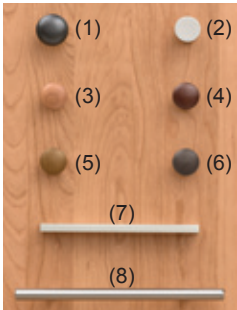

- Knobs:**
 (1) MMA-210
 (2) FTN-150
 (3) MRC-003
 (4) MRC-033
 (5) MRC-043
 (6) MRC-053

- Pulls:**
 (7) ABN-150
 (8) BRN-155

Leather Options



ebony (12)

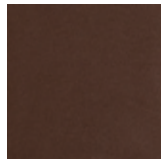

coffee (14)



white (16)

THE DOMINION BEDROOM

Eighty Four Beds in One

Dominion beds are available in a wide variety of styles and configurations. Each of the five headboard designs may be ordered in two sizes (queen or king), four finishes, with three leather options for the upholstered bed and three basic configurations: standard box spring with mattress bed, platform bed or storage bed.



18" High Box Spring & Mattress Combo (10)



12" High Mattress only Platform Bed (20)

	w	l	h
queen	64"	84"	50"
king	80"	84"	50"
cal king	76"	88"	50"

The Dominion Bedroom is Made to Order in four finishes* (specify conventional or water borne finish) with a variety of knob or pull options. All pieces are crafted in solid cherry hardwood**

*Natural variations in solid wood and hand-applied finishes make each piece unique. Slight grain and irregularities as well as subtle differences in stain shades are signs that the furniture has been crafted from solid wood and are considered hallmarks of quality.
**Bed siderails are laminated with cherry veneer.



12" High Mattress only Storage Bed (30)

Unique Storage Nightstand provides proper function for storage drawers.



THE DOMINION BEDROOM

Full assortment of Case Pieces



Case Features:

- Constructed of solid North American Cherry hardwood.
- Captured 1/4" Baltic Birch plywood case backs adding significant strength and rigidity.
- Solid wood drawer fronts, sides and backs. Integrated drawer front with Asymmetrical English Dovetail joinery.
- Fully finished and sanded drawer interiors. Drawer bottoms are jet-welded 1/4" Baltic Birch plywood.
- Fully adjustable wood on wood drawer glides for smooth operation in any environment.

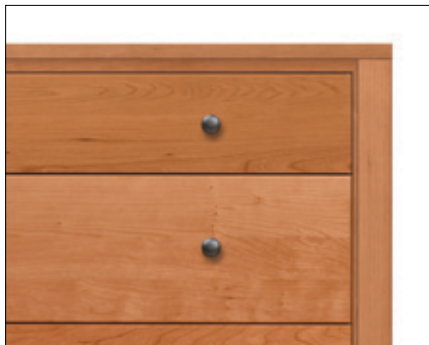

Flush Mounted Top (01)

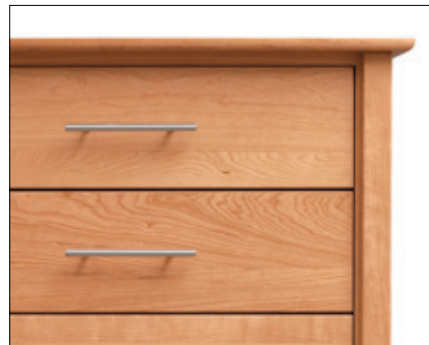

Overhanging Top (03)



THE DOMINION BEDROOM



left storage nightstand



2-DOM-01
22" x 15 1/2" x 23 1/4"H

right storage nightstand



2-DOM-02
22" x 15 1/2" x 23 1/4"H

1 drawer



2-DOM-10
25 1/4" (27 3/4") x 18 3/4" (20") x 26"H

6 drawer

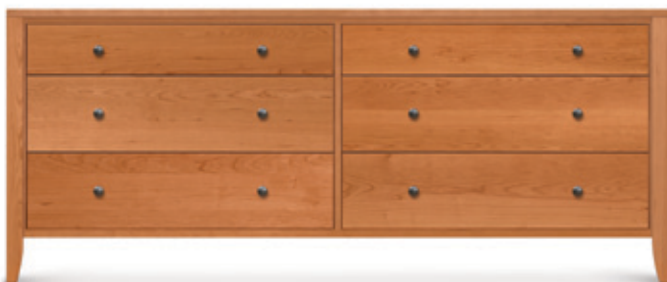

2-DOM-60
70 1/8" (72 5/8") x 18 3/4" (20") x 28 3/4"H

3 drawer



2-DOM-30
36 7/8" (39 3/8") x 18 3/4" (20") x 28 3/4"H

THE DOMINION BEDROOM



3 drawer + tv organizer



2-DOM-35
36 7/8" (39 3/8") x 18 3/4 (20") x 36 7/8"H

cabinet + tv organizer



4-DOM-30
36 7/8" (39 3/8") x 18 3/4 (20") x 36 7/8"H

4 drawer



2-DOM-40
36 7/8" (39 3/8") x 18 3/4 (20") x 36 7/8"H

cabinet + 1 drawer



4-DOM-31
36 7/8" (39 3/8") x 18 3/4 (20") x 36 7/8"H

THE DOMINION BEDROOM



wall mirror



5-CAR-21
49 3/4 x 1 1/4 x 32 3/4"H

8 drawer



2-DOM-80
70 1/8" (72 5/8") x 18 3/4 (20") x 36 7/8"H

THE DOMINION BEDROOM



5 drawer



2-DOM-50
31 1/4" (33 3/4") x 18 3/4" (20") x 48 1/2"H

floor mirror



5-BER-30
25 1/4" x 19 1/2" x 64"H



mansfield bed

queen
king
cal king

	w	l	h
1-MAN-02-03	63"	84"	40"
1-MAN-01-03	79"	84"	40"
1-MAN-05-03	75"	88"	40"

mansfield bedroom

The Mansfield Bedroom represents a striking combination of the familiar and the unconventional. Mitered frames support the cases producing complex facets that create visual interest and highlight the collection's solid Cherry construction. The geometry of the black bronze ring pulls reflects that of the overall collection and is a fresh take on a traditional form. The bed is low and sleek, designed for a mattress only. It is perfectly complemented by a selection of case pieces, including a 3 drawer chest with organizer options for home entertainment equipment and a laptop desk that creates a trim, functional workspace.

The Mansfield Bedroom is Made to Order in six finishes* (specify conventional or water borne finish) with a variety of knob or pull options.

*Natural variations in solid wood and hand-applied finishes make each piece unique. Slight grain and irregularities as well as subtle differences in stain shades are signs that the furniture has been crafted from solid wood and are considered hallmarks of quality.

1 drawer



2-MAN-11-03
18 1/2" x 18" x 23 1/4"

3 drawer



2-MAN-31-03
33 1/2" x 18" x 31 1/4"H

4 drawer



2-MAN-41-03
33 1/2" x 18" x 37 3/8"H

wall mirror



5-MAN-21-03
30"W x 28 3/4"H x 1 1/4"Deep

3 drawer + tv organizer



2-MAN-36-03
33 1/2" x 18" x 37 3/8"H

laptop desk



3-MAN-21-03
33 1/2" x 18" x 37 3/8"H

5 drawer



2-MAN-51-03
26 7/8" x 18" x 51 3/8"H

6 drawer



2-MAN-61-03
66 1/8" x 18" x 31 1/4"H

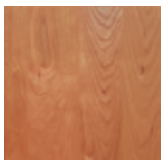

natural cherry (03)

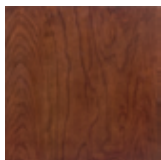

windsor cherry (13)



autumn cherry (23)

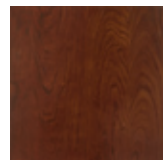

cognac cherry (33)

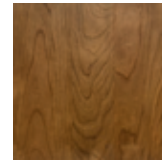

saddle cherry (43)

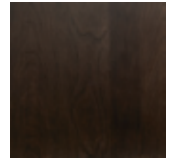

smoke cherry (53)



m i m o b e d r o o m

MiMo, a portmanteau for Miami Modernist Architecture, is defined by the juxtaposition of glamorous materials with minimalist styling. The MiMo bedroom collection, with its metallic and Walnut accents, combines a stark Modernist form with a touch of flair for a design that is both graceful and timeless.

The MiMo Bedroom is crafted in solid maple hardwood with white finish and American black walnut hardwood with natural finish with your choice of bronze (100) or nickel (200) legs and a variety of knob or pull options.

Upholstered MiMo headboards are available in a range of microsuedes and fabrics as well as COM (customer's own material). Please refer to the upholstery page of this catalog for options. Note: leather is not available on the MiMo bed.

bronze (100)



nickel (200)



mimo bed - wood panel headboard

		w	l	h
queen	1-MIM-02-14-xxx	66"	87 5/8"	42"
king	1-MIM-01-14-xxx	82"	87 5/8"	42"
cal king	1-MIM-05-14-xxx	78"	91 5/8"	42"
shelf nightstand	2-MIM-01-51	13"	15"	1 1/2"H



mimo bed - upholstered headboard (no buttons)

		w	l	h
queen	1-MIM-22-14-xxx	66"	87 5/8"	42"
king	1-MIM-21-14-xxx	82"	87 5/8"	42"
cal king	1-MIM-25-14-xxx	78"	91 5/8"	42"



mimo bed - upholstered headboard with buttons

		w	l	h
queen	1-MIM-32-14-xxx	66"	87 5/8"	42"
king	1-MIM-31-14-xxx	82"	87 5/8"	42"
cal king	1-MIM-35-14-xxx	78"	91 5/8"	42"

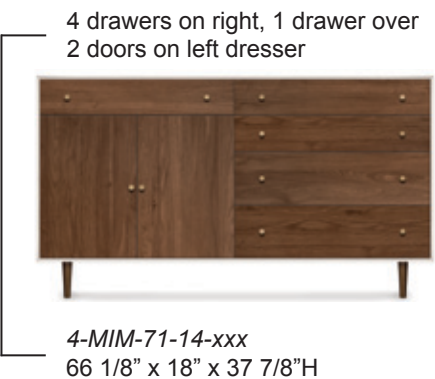
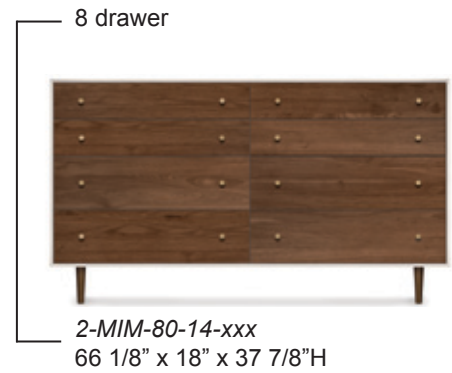
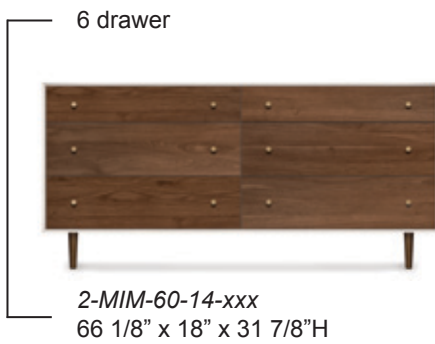
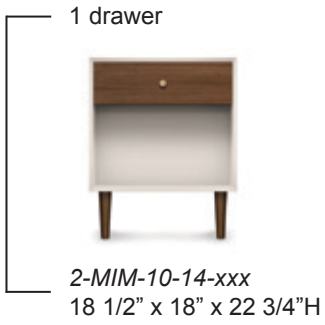



moduluxe bedroom



copeland

FURNITURE

copelandfurniture.com



moduluxe is sectional
furniture for the bedroom.



Individual pieces within the collection can stand alone as stylish contemporary designs or can be arranged in a modular sectional for a semi-built-in configuration.

Whether you're imagining a conventional bedroom set or a sectional configuration, Moduluxe has the versatility and range of options to realize your vision.



moduluxe is versatility.

Platform beds and cases are available in heights of either 29" or 35". A 35" high storage bed is also available.

Three unique headboard designs are available: a flat panel design, an upholstered design and a louvered "clapboard" design.

Cases, desks and media units are available in a wide range of configurations.

The Moduluxe Bedroom is crafted in solid maple, cherry or American black walnut hardwood* and Made to Order in fifteen finishes** (specify conventional or water borne finish) with a variety of knob or pull options.

*Bed headboard panel is laminated with maple, cherry or walnut veneer.
**Natural variations in solid wood and hand-applied finishes make each piece unique. Slight grain and irregularities as well as subtle differences in stain shades are signs that the furniture has been crafted from solid wood and are considered hallmarks of quality.



29" High Bed



35" High Bed

35" High Case

29" High Case



In basic functional terms the difference between the 29" high case series and the 35" high case series may be understood as the difference of one drawer - as with the three and four drawer cases shown here.

For the consumer, selecting 29" high Moduluxe bedroom vs. 35" Moduluxe bedroom will be a question of aesthetic preference, storage needs and/or space limitations in the intended room.

moduluxe headboard designs



Panel Headboard

Simple design emphasizing the character of the wood grain itself.



Upholstered Headboard

Horizontal bolsters available in microsuede or full aniline dyed leather in multiple colors as well as customer's own material.



Louvered Headboard

This "clapboard" style design emphasizes the character of the wood grain with slightly more geometric detail than the panel headboard.

29" high beds and nightstands

The Moduluxe Bedroom is crafted in solid maple, cherry or American black walnut hardwood* and Made to Order in fifteen finishes** (specify conventional or water borne finish) with a variety of knob or pull options.

*Bed headboard panel is laminated with maple, cherry or walnut veneer.

**Natural variations in solid wood and hand-applied finishes make each piece unique. Slight grain and irregularities as well as subtle differences in stain shades are signs that the furniture has been crafted from solid wood and are considered hallmarks of quality.

moduluxe 29" high plinth base bed with veneer headboard

queen
king
cal king

		w	l	h
	1-MVD-22-04	66"	86"	29"
	1-MVD-21-04	82"	86"	29"
	1-MVD-25-04	78"	90"	29"



moduluxe 29" high plinth base bed with upholstery headboard

queen
king
cal king

		w	l	h
	1-MPD-22-04	66"	86"	29"
	1-MPD-21-04	82"	86"	29"
	1-MPD-25-04	78"	90"	29"



moduluxe 29" high plinth base bed with clapboard headboard

queen
king
cal king

		w	l	h
	1-MCD-22-04	66"	86"	29"
	1-MCD-21-04	82"	86"	29"
	1-MCD-25-04	78"	90"	29"



29" high box nightstand to match plinth base bed - 18 1/2" wide



2-MOD-01-04
18 1/2" x 18" x 29"H

29" high shelf nightstand to match plinth base bed - 18 1/2" wide



2-MOD-03-04
18 1/2" x 18" x 29"H

29" high box nightstand to match plinth base bed - 24" wide



2-MOD-02-04
24" x 18" x 29"H

29" high shelf nightstand to match plinth base bed - 24" wide



2-MOD-04-04
24" x 18" x 29"H

29" high cases

narrow cases

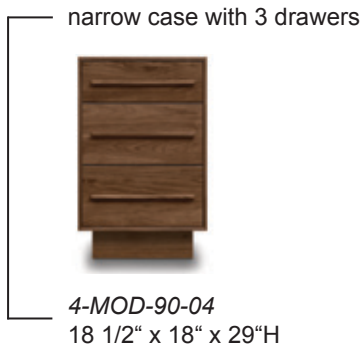

double cases

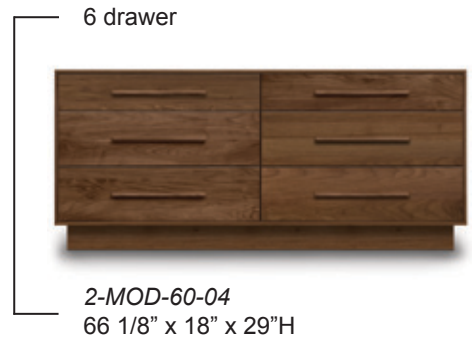

single cases

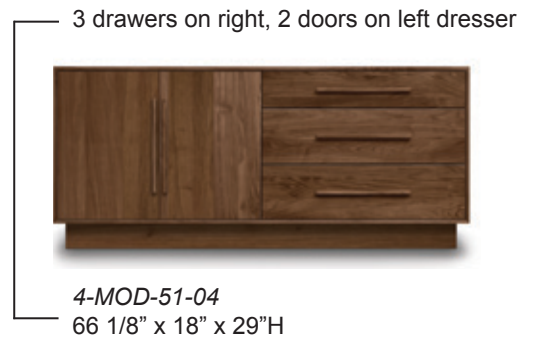
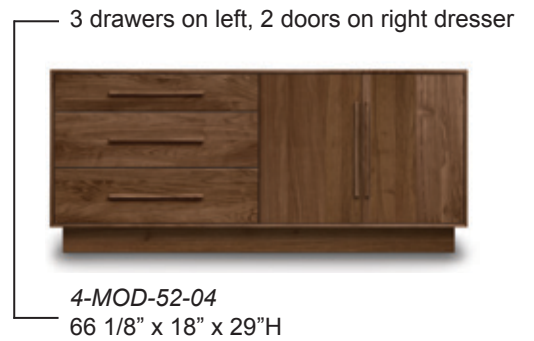

corner cases

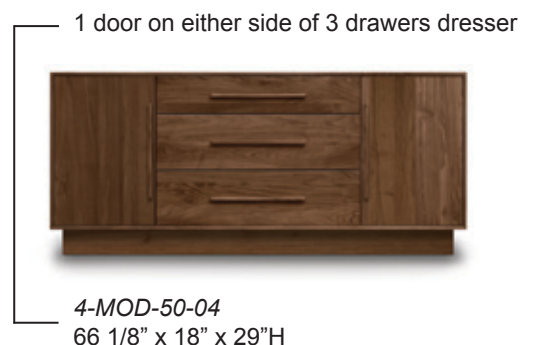
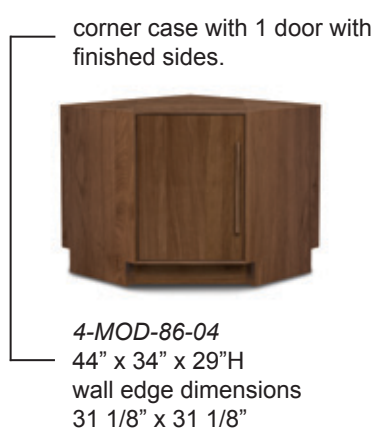
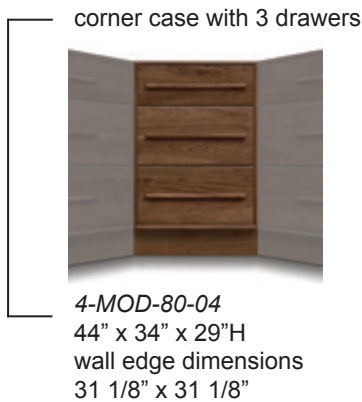

35" high beds and nightstands

The Moduluxe Bedroom is crafted in solid maple, cherry or American black walnut hardwood* and Made to Order in fifteen finishes** (specify conventional or water borne finish) with a variety of knob or pull options.

*Bed headboard panel is laminated with maple, cherry or walnut veneer.

**Natural variations in solid wood and hand-applied finishes make each piece unique. Slight grain and irregularities as well as subtle differences in stain shades are signs that the furniture has been crafted from solid wood and are considered hallmarks of quality.

moduluxe 35" high plinth base bed with veneer headboard

queen
king
cal king

		w	l	h
	<i>1-MVD-32-04</i>	66"	86"	35"
	<i>1-MVD-31-04</i>	82"	86"	35"
	<i>1-MVD-35-04</i>	78"	90"	35"



35" high box nightstand to match plinth base bed - 18 1/2" wide



2-MOD-05-04
18 1/2" x 18" x 35"H

moduluxe 35" high plinth base bed with upholstery headboard

queen
king
cal king

		w	l	h
	<i>1-MPD-32-04</i>	66"	86"	35"
	<i>1-MPD-31-04</i>	82"	86"	35"
	<i>1-MPD-35-04</i>	78"	90"	35"



35" high shelf nightstand to match plinth base bed - 18 1/2" wide



2-MOD-07-04
18 1/2" x 18" x 35"H

moduluxe 35" high plinth base bed with clapboard headboard

queen
king
cal king

		w	l	h
	<i>1-MCD-32-04</i>	66"	86"	35"
	<i>1-MCD-31-04</i>	82"	86"	35"
	<i>1-MCD-35-04</i>	78"	90"	35"



35" high shelf nightstand to match plinth base bed - 24" wide



2-MOD-08-04
24" x 18" x 35"H

35" high box nightstand to match plinth base bed - 24" wide



2-MOD-06-04
24" x 18" x 35"H

35" high storage beds and nightstands

Space, style and function are the three main themes expressed in the moduluxe storage bed. With 4, eight inch deep, sub-mounted drawers, the bed provides plenty of inconspicuous storage, allowing for a roomier living environment. The storage bed is crafted in solid maple, cherry or American black walnut hardwood* and Made to Order in fifteen finishes** (specify conventional or water borne finish) with a variety of knob or pull options.

*Bed headboard panel is laminated with maple, cherry or walnut veneer.

**Natural variations in solid wood and hand-applied finishes make each piece unique. Slight grain and irregularities as well as subtle differences in stain shades are signs that the furniture has been crafted from solid wood and are considered hallmarks of quality.

moduluxe 35" high storage base bed with veneer headboard

		w	l	h
queen	1-MVD-32-04-STOR	66"	86"	35"
king	1-MVD-31-04-STOR	82"	86"	35"
cal king	1-MVD-35-04-STOR	78"	90"	35"



35" high box nightstand to match storage base bed - 18 1/2" wide



2-MSD-05-04
18 1/2" x 18" x 35"H

35" high shelf nightstand to match storage base bed - 18 1/2" wide



2-MSD-07-04
18 1/2" x 18" x 35"H

moduluxe 35" high storage base bed with upholstery headboard

		w	l	h
queen	1-MPD-32-04-STOR	66"	86"	35"
king	1-MPD-31-04-STOR	82"	86"	35"
cal king	1-MPD-35-04-STOR	78"	90"	35"



35" high box nightstand to match storage base bed - 24" wide



2-MSD-06-04
24" x 18" x 35"H

moduluxe 35" high storage base bed with clapboard headboard

		w	l	h
queen	1-MCD-32-04-STOR	66"	86"	35"
king	1-MCD-31-04-STOR	82"	86"	35"
cal king	1-MCD-35-04-STOR	78"	90"	35"



35" high shelf nightstand to match storage base bed - 24" wide



2-MSD-08-04
24" x 18" x 35"H

35" high cases

single cases

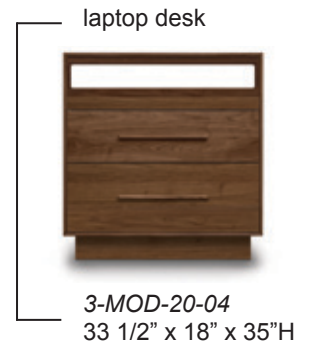
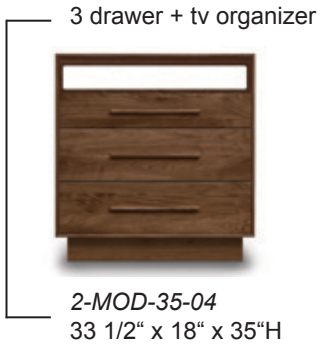

corner cases

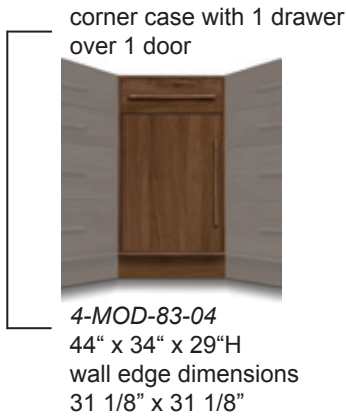
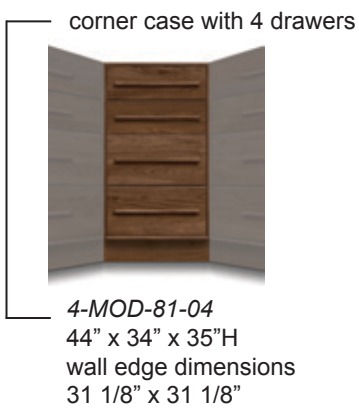

double cases

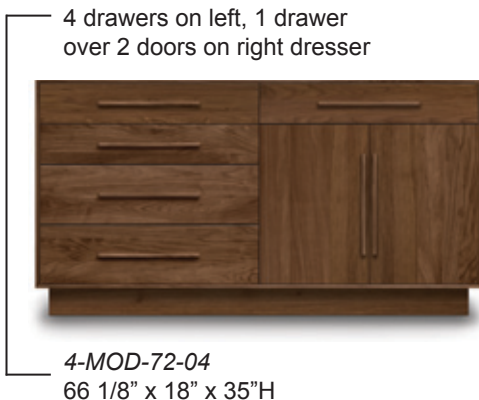

narrow cases

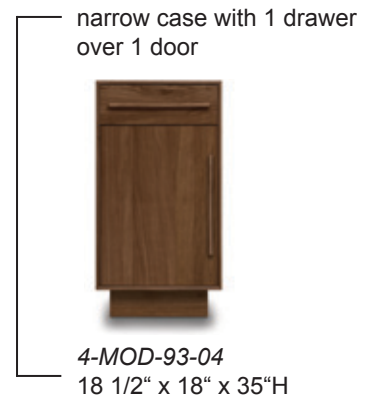
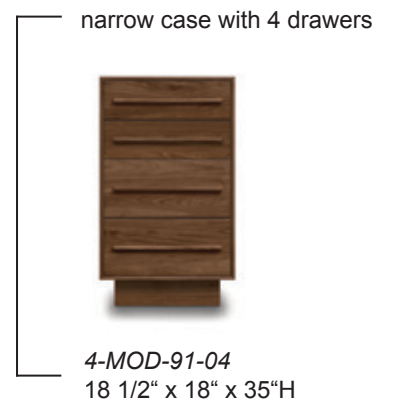

other cases and mirrors

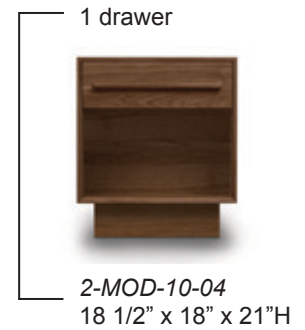
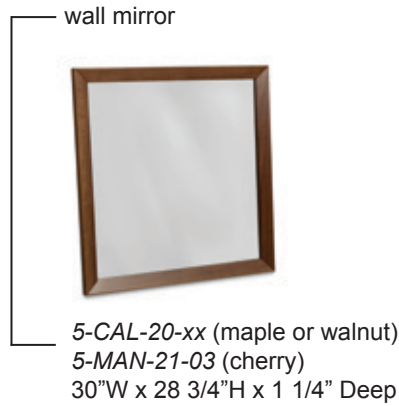

finish options

Natural variations in solid wood and hand-applied finishes make each piece unique. Slight grain and irregularities as well as subtle differences in stain shades are signs that the furniture has been crafted from solid wood and are considered hallmarks of quality.

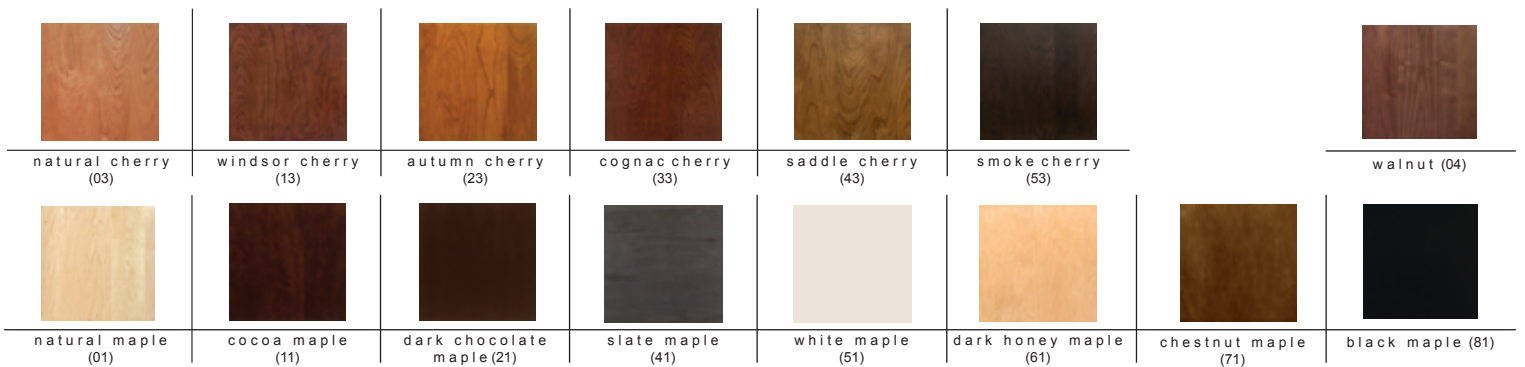

upholstery options

Upholstered items are available in a range of microsuede, fabric or leather colors as well as COM (customer's own material). Please refer to the upholstery page of this catalog.

hardware

When arranged in a sectional configuration, Moduluxe cases should be leveled with the built-in leg levelers. The levelers are accessed through holes in each corner of the inside bottom of the case. A special 5mm hex-drive ratchet is required for the adjustment. This tool is included only with Moduluxe corner cases although it may be purchased separately. This operation is not necessary when the cases and beds are arranged separately from each other.

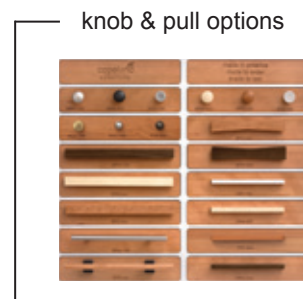

planning a moduluxe sectional bedroom

There are several questions that should be considered before planning a Moduluxe sectional configuration:

- Approximately how many storage drawers and/or shelves are needed for the space in question?
- Does a desk or media unit need to be incorporated into the floor plan?
- What are the dimensions of the room in question?
- Are there any architectural elements like window casings, soffits, light switches, etc. that preclude certain pieces?



typical moduluxe sectionals

Once the questions above are answered it's time to start configuring the actual space. Most Moduluxe bedrooms will be laid out in a common "L" sectional. This requires an open corner of a room and some length extending in both directions. Starting at the corner, measure the available space along each of the two walls.

common moduluxe dimensions

The diagrams below illustrate a top-down view and floor plan dimensions of the various Moduluxe pieces:

- Beds are available in three standard North American sizes: Queen, King and California King.
- Nightstands are available in one of two standards widths.
- Moduluxe cases come in one of three standard widths.
- All Corner Cabinets occupy a footprint of the same dimension.

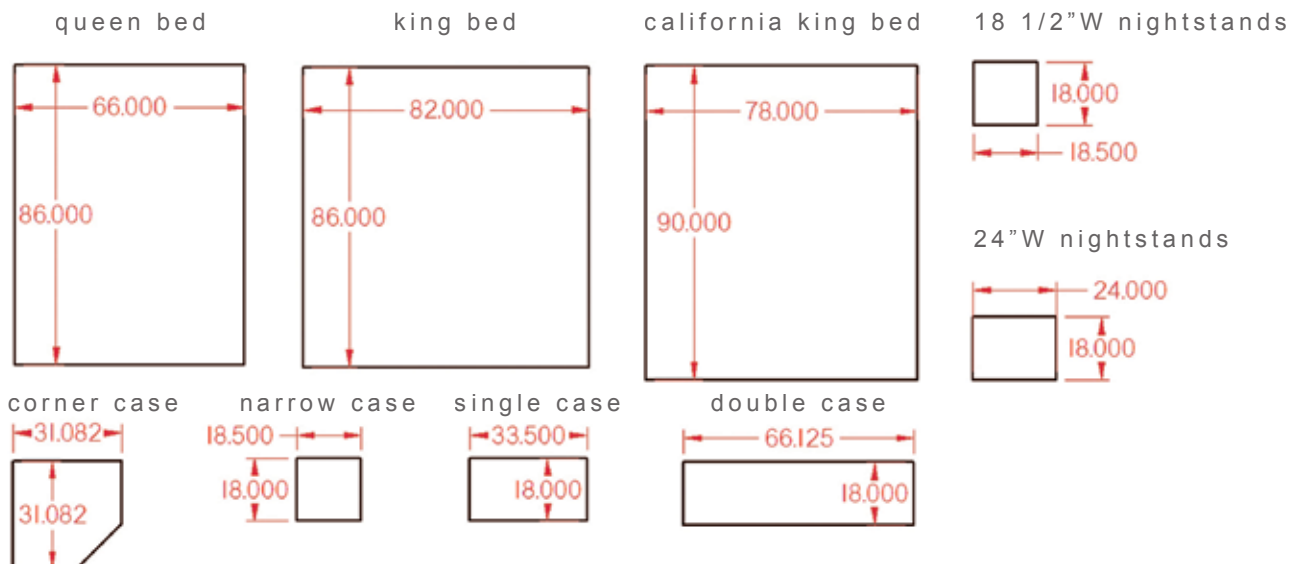

common "L" configurations

The following common floor plans can be used as a quick reference to judge space requirements.

queen bed
18.5" nightstands
single case
corner case
narrow case

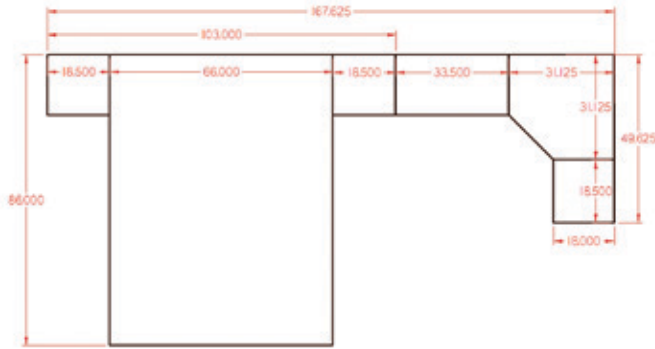

queen bed
24" nightstands
2 single cases
corner case

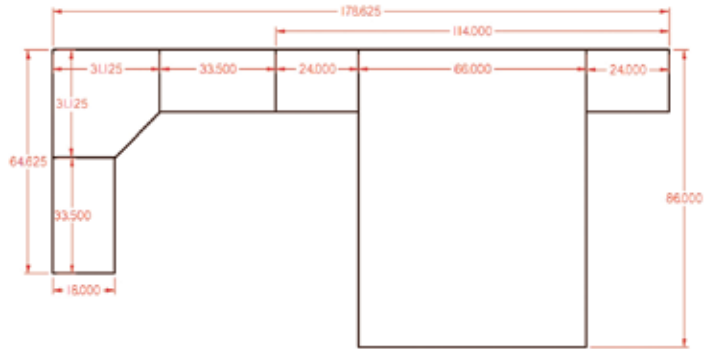

cal-king bed
18.5" nightstands
2 narrow cases
corner case
single case

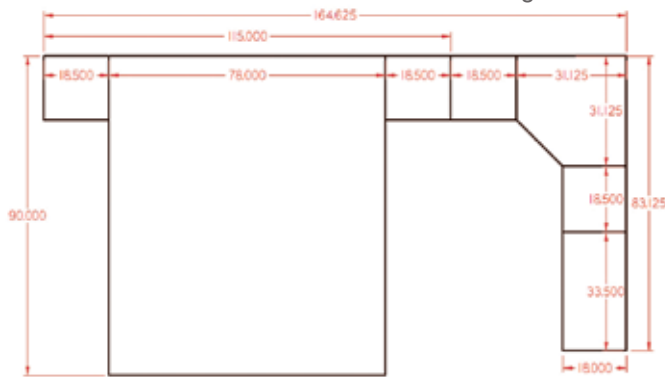

cal-king bed
24" nightstands
narrow case
corner case
double case

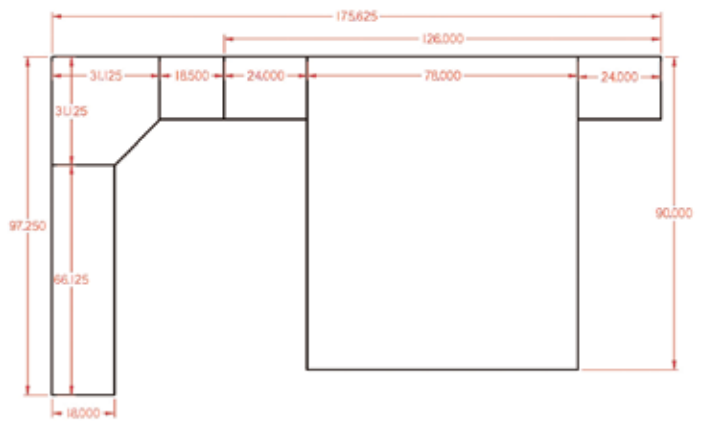

king bed
18.5" nightstands
corner case
narrow case
double case

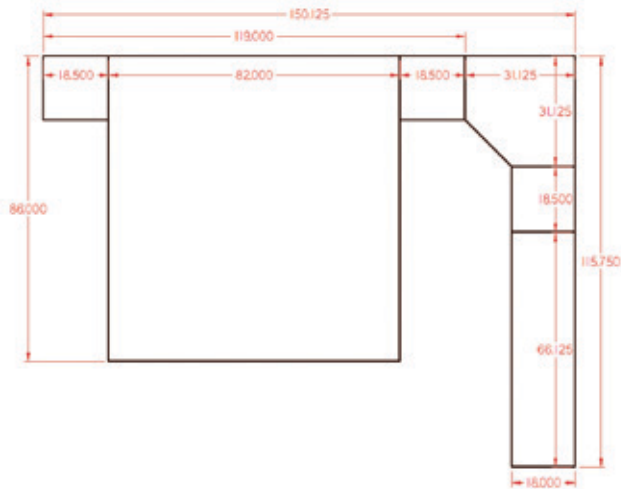

king bed
24" nightstands
corner case
single case
double case

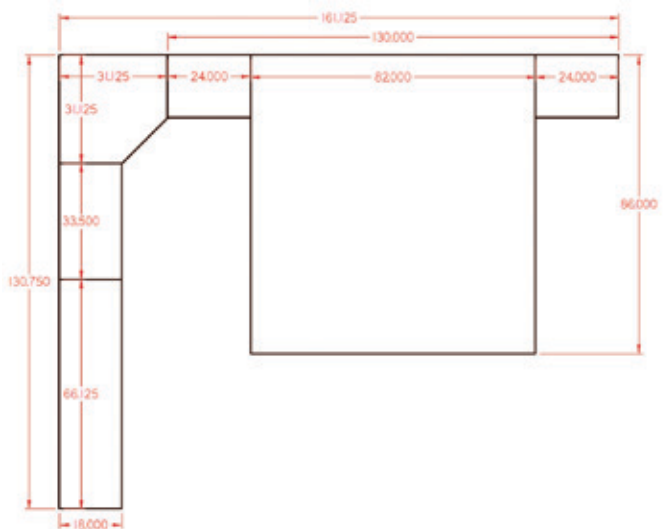



moduluxe bedroom

copeland
FURNITURE
copelandfurniture.com



about copeland

Timeless design, heirloom quality and a genuine commitment to sustainability are what you receive when you buy a Copeland Furniture product. For over 35 years we have been designing and manufacturing high quality, solid wood furniture in Bradford, Vermont. Even as styles change, at Copeland Furniture we remain true to our roots as expressed in the old New England adage “make it last, wear it out, make it do or do without.” This is the antithesis of today’s disposable culture where both the style and even products themselves are intended to require frequent replacement. We design our furniture to be with you for life and handed down to subsequent generations. This emanates from our firmly held belief that permanence is the essence of sustainability. Our values are also informed by New England’s Shaker communities who taught “Don’t make something unless it is both necessary and useful; but if it is both necessary and useful, don’t hesitate to make it beautiful.” The combination of this ethic and our use of high quality, traditional materials results in a simple, clean lined Modernism that transcends fashion or style and speaks directly to our customer’s best qualities.

Please visit us on the web and learn more about Copeland Furniture. www.copelandfurniture.com



monterey bed

	w	l	h
full	58 1/4"	79"	52"
queen	64 1/4"	84"	52"
king	80 1/4"	84"	52"
cal king	76 1/4"	88"	52"

monterey bedroom

The Monterey Bedroom gives traditional Arts & Crafts an Asian touch. The clean lines of the Monterey beds are perfectly complemented by a selection of case pieces. All pieces are crafted in solid cherry hardwood.* The Monterey bed is designed for use with a mattress only. The Monterey Bedroom is Made to Order in six finishes** (specify conventional or water borne finish) with a variety of knob or pull options.

*Cases sides are laminated with cherry veneer.

**Natural variations in solid wood and hand-applied finishes make each piece unique. Slight grain and irregularities as well as subtle differences in stain shades are signs that the furniture has been crafted from solid wood and are considered hallmarks of quality.



monterey bed with upholstered panel

		w	l	h
full	1-MON-23-03	58 1/4"	79"	52"
queen	1-MON-22-03	64 1/4"	84"	52"
king	1-MON-21-03	80 1/4"	84"	52"
cal king	1-MON-25-03	76 1/4"	88"	52"

bench and bed upholstery options

Upholstered items are available in a range of microsuede, fabric or leather colors as well as COM (customer's own material). Please refer to the upholstery page of this catalog.

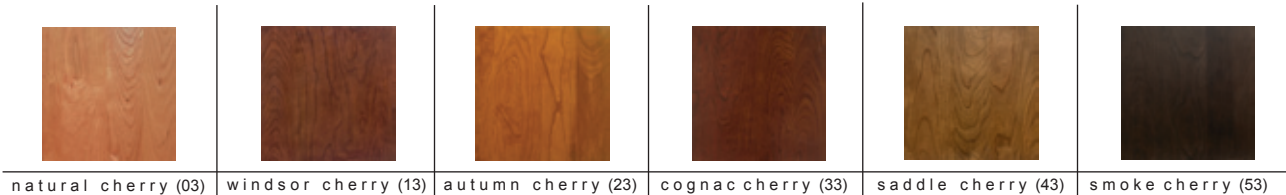

natural cherry (03) | windsor cherry (13) | autumn cherry (23) | cognac cherry (33) | saddle cherry (43) | smoke cherry (53)



monterey bed with storage

		w	l	h
full	1-MON-13-03-STOR	58 1/4"	79"	52"
queen	1-MON-12-03-STOR	64 1/4"	84"	52"
king	1-MON-11-03-STOR	80 1/4"	84"	52"
cal king	1-MON-15-03-STOR	76 1/4"	88"	52"



Detail of Berkeley Bed with storage



monterey bed with storage and upholstered panel

		w	l	h
full	1-MON-23-03-STOR	58 1/4"	79"	52"
queen	1-MON-22-03-STOR	64 1/4"	84"	52"
king	1-MON-21-03-STOR	80 1/4"	84"	52"
cal king	1-MON-25-03-STOR	76 1/4"	88"	52"

Space, style and function are the three main themes expressed in the Monterey storage bed. With 4, eight inch deep, sub-mounted drawers, the bed provides plenty of inconspicuous storage, allowing for a roomier living environment. The Monterey storage bed is unique, in that the drawers are mounted six inches above the floor allowing for easier access than other storage beds. The Monterey bed is crafted in solid cherry hardwood. The optional nightstands, also crafted in solid cherry are designed to allow easy access to the storage drawers. All pieces are Made to Order in six finishes* (specify conventional or water borne finish) with a variety of knob or pull options.

nighstand - left



2-BER-01-03
22" x 15 1/2" x 26"H

nighstand - right



2-BER-02-03
22" x 15 1/2" x 26"H

1 drawer



2-MNT-10-03
21 3/4" x 20" x 25 1/2"H

2 drawer



2-MNT-20-03
23 3/4" x 22" x 25 1/2"H

2 drawer + tv organizer



2-MNT-25-03
33 3/4" x 20 1/4" x 35 1/4"H

3 drawer



2-MNT-30-03
33 3/4" x 20 1/4" x 35 1/4"H

4 drawer dresser + tv organizer



2-MNT-46-03
58 3/4" x 20 1/4" x 35 1/4"H

4 drawer chest + tv organizer



2-MNT-45-03
33 3/4" x 20 1/4" x 50"H

5 drawer



2-MNT-50-03
33 3/4" x 20 1/4" x 50"H

8 drawer + tv organizer



2-MNT-85-03
58 3/4" x 20 1/4" x 50"H

6 drawer & accessory case



2-MNT-60-03
58 3/4" x 20 1/4" x 35 1/4"H
5-MNT-10-03
49 3/4" x 16" x 6 1/4"H

floor mirror



5-BER-30-03
25 1/4" x 19 1/2" x 64"H

wall mirror

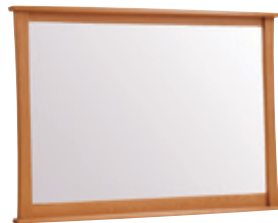

5-BER-21-03
52"W x 34 1/4"H x 3"Deep

10 drawer



2-MNT-80-03
58 3/4" x 20 1/4" x 50"H

bench



5-BER-60-03
58 3/4" x 20 1/4" x 35 1/4"H

7 drawer



2-MNT-70-03
23 3/4" x 22" x 61"H



sarah sleigh bed - high footboard - 51"H headboard

		w	l	h
twin	1-SLV-14-03	41 1/2"	94 1/2"	51"
full	1-SLV-13-03	56 1/2"	94 1/2"	51"
queen	1-SLV-12-03	62 1/2"	99 1/2"	51"
king	1-SLV-11-03	78 1/2"	99 1/2"	51"
cal king	1-SLV-15-03	74 1/2"	103 1/2"	51"

sarah sleigh bed - high footboard - 45"H headboard (not shown)

		w	l	h
twin	1-SLM-14-03	41 1/2"	94 1/2"	45"
full	1-SLM-13-03	56 1/2"	94 1/2"	45"
queen	1-SLM-12-03	62 1/2"	99 1/2"	45"
king	1-SLM-11-03	78 1/2"	99 1/2"	45"
cal king	1-SLM-15-03	74 1/2"	103 1/2"	45"

sarah sleigh bed - low footboard - 45"H headboard

		w	l	h
twin	1-SLP-14-03	41 1/2"	85 1/5"	45"
full	1-SLP-13-03	56 1/2"	85 1/2"	45"
queen	1-SLP-12-03	62 1/2"	90 1/2"	45"
king	1-SLP-11-03	78 1/2"	90 1/2"	45"
cal king	1-SLP-15-03	74 1/2"	94 1/2"	45"



sarah bedroom in cherry

The Sarah Bedroom exhibits the clean lines and balanced proportions of its Shaker influence. At the center of the Sarah Bedroom is the striking bed design of the romantic raised panel sleigh bed. It has a generous headboard and can be configured for a mattress and box spring or mattress only. The Sarah Sleigh bed with a high footboard is available with either a 51" or 45" high headboard.

All pieces are made of solid cherry hardwood* and Made to Order in six finishes** (specify conventional or water borne finish) with a variety of knob or pull options. The cases are also available in maple hardwood* and Made to order in eight finishes** (specify conventional or water borne finish) with a variety of knob or pull options.

*Case sides are laminated with cherry or maple veneer.

**Natural variations in solid wood and hand-applied finishes make each piece unique. Slight grain and irregularities as well as subtle differences in stain shades are signs that the furniture has been crafted from solid wood and are considered hallmarks of quality.

sarah bed with storage

		w	l	h
full	1-SLV-23-03-STOR	56 1/2"	95 1/2"	48"
queen	1-SLV-22-03-STOR	62 1/2"	99 1/2"	48"
king	1-SLV-21-03-STOR	78 1/2"	99 1/2"	48"
cal king	1-SLV-25-03-STOR	74 1/2"	103 1/2"	48"



Detail of Sarah Bed with storage

Space, style and function are the three main themes expressed in the storage bed. With 4, eight inch deep, sub-mounted drawers, the bed provides plenty of inconspicuous storage, allowing for a roomier living environment. The sleigh storage bed is unique, in that the drawers are mounted six inches above the floor allowing for easier access than other storage beds. The storage bed is crafted in solid cherry hardwood.

The optional nightstands, also crafted in solid cherry are designed to allow easy access to the storage drawers.

All pieces are Made to Order in six finishes** (specify conventional or water borne finish) with a variety of knob or pull options.

nighstand - left



2-SRH-01-03
22" x 15 1/2" x 26"H

nighstand - right



2-SRH-02-03
22" x 15 1/2" x 26"H

1 drawer



2-SRH-11-03 22" x 22" x 24"H
2-SRH-12-03 22" x 22" x 28"H

2 drawer



2-SRH-20-03 24" x 24" x 24"H
2-SRH-21-03 24" x 24" x 28"H

3 drawer



2-SRH-31-03
33 3/4" x 20 1/4" x 33 3/4"H

6 drawer & accessory case



2-SRH-61-03
59 1/4" x 20 1/4" x 33 1/4"H
5-SRH-10-03 51" x 16" x 6"H

5 drawer



2-SRH-51-03
33 3/4" x 20 1/4" x 48 1/2"H

7 drawer



2-SRH-70-03
24" x 24" x 59 1/2"H

10 drawer



2-SRH-80-03
59 1/4" x 20 1/4" x 48 1/2"H

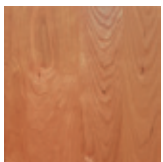

natural cherry (03)

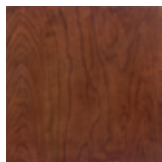

windsor cherry (13)



autumn cherry (23)

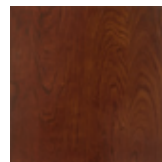

cognac cherry (33)



saddle cherry (43)

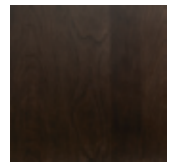

smoke cherry (53)



sarah bedroom in cherry & maple

The Sarah Bedroom is also available in a solid cherry/solid maple combination. This striking yet subtle contrast of solid hardwoods adds dimension to the Sarah Sleigh bed and case pieces.

The Sarah Bedroom is made of solid cherry and maple* and Made to Order with a variety of knob or pull options. Specify conventional or water borne finish. The cases are also available in maple hardwood* and Made to order in eight finishes** (specify conventional or water borne finish) with a variety of knob or pull options.

*Case sides are laminated with maple veneer.

**Natural variations in solid wood and hand-applied finishes make each piece unique. Slight grain and irregularities as well as subtle differences in stain shades are signs that the furniture has been crafted from solid wood and are considered hallmarks of quality.



sarah sleigh bed - high footboard - 51"H headboard

		w	l	h
twin	1-SLV-14-02	41 1/2"	94 1/2"	51"
full	1-SLV-13-02	56 1/2"	94 1/2"	51"
queen	1-SLV-12-02	62 1/2"	99 1/2"	51"
king	1-SLV-11-02	78 1/2"	99 1/2"	51"
cal king	1-SLV-15-02	74 1/2"	103 1/2"	51"
2 drawer	2-SRH-20-02	24"	24"	24"
	2-SRH-21-02	24"	24"	28"

sarah sleigh bed - high footboard - 45"H headboard (not shown)

		w	l	h
twin	1-SLM-14-02	41 1/2"	94 1/2"	45"
full	1-SLM-13-02	56 1/2"	94 1/2"	45"
queen	1-SLM-12-02	62 1/2"	99 1/2"	45"
king	1-SLM-11-02	78 1/2"	99 1/2"	45"
cal king	1-SLM-15-02	74 1/2"	103 1/2"	45"

sarah sleigh bed - low footboard - 45"H headboard

		w	l	h
twin	1-SLP-14-02	41 1/2"	85 1/2"	45"
full	1-SLP-13-02	56 1/2"	85 1/2"	45"
queen	1-SLP-12-02	62 1/2"	90 1/2"	45"
king	1-SLP-11-02	78 1/2"	90 1/2"	45"
cal king	1-SLP-15-02	74 1/2"	94 1/2"	45"
1 drawer	2-SRH-11-02	22" x 22"	24"	
	2-SRH-12-02	22" x 22"	28"	



Space, style and function are the three main themes expressed in the storage bed. With 4, eight inch deep, sub-mounted drawers, the bed provides plenty of inconspicuous storage, allowing for a roomier living environment. The sleigh storage bed is unique, in that the drawers are mounted six inches above the floor allowing for easier access than other storage beds. The storage bed is crafted in solid cherry and maple hardwood.

The optional nightstands, crafted in solid maple are designed to allow easy access to the storage drawers. The storage bed is Made to Order with a variety of knob or pull options.



sarah bed with storage

		w	l	h
full	1-SLV-23-02-STOR	56 1/2"	95 1/2"	48"
queen	1-SLV-22-02-STOR	62 1/2"	99 1/2"	48"
king	1-SLV-21-02-STOR	78 1/2"	99 1/2"	48"
cal king	1-SLV-25-02-STOR	74 1/2"	103 1/2"	48"



Detail of Sarah Bed with storage

nighstand - left



2-SRH-01-01
22" x 15 1/2" x 26"

3 drawer



2-SRH-31-01
33 3/4" x 20 1/4" x 33 3/4"H

5 drawer



2-SRH-51-02
33 3/4" x 20 1/4" x 48 1/2"H

7 drawer



2-SRH-70-02
24" x 24" x 59 1/2"H

nighstand - right



2-SRH-02-01
22" x 15 1/2" x 26"H

6 drawer & accessory case



2-SRH-61-02
59 1/4" x 20 1/4" x 33 3/4"H
5-SRH-10-02 51" x 16" x 6"

10 drawer



2-SRH-80-02
59 1/4" x 20 1/4" x 48 1/2"H



soho bedroom

Accepting the premise that we shape our surroundings and then our surroundings shape us, the SoHo Bedroom seeks to instill the feelings of comfort and clarity. Borrowing elements from the best of traditional and contemporary design, SoHo falls into a category of its own; Modern-Classic. From the 'floating cabinet' motif of Mid-Century-Modern design to the updated Panel bed – designed for use with a mattress only, SoHo subtly evokes harmony, simplicity and versatility.

The SoHo Bedroom is crafted in solid walnut and maple or cherry and is available in an assortment of species combinations and knob and pull options for a highly customizable room setting. Specify conventional or water borne finish.



soho panel bed - walnut and cherry

		w	l	h
queen	1-SOH-22-34	66 1/2"	88 1/2"	40"
king	1-SOH-21-34	82 1/2"	88 1/2"	40"
cal king	1-SOH-25-34	78 1/2"	92 1/2"	40"



soho panel bed - walnut and maple

		w	l	h
queen	1-SOH-22-14	66 1/2"	88 1/2"	40"
king	1-SOH-21-14	82 1/2"	88 1/2"	40"
cal king	1-SOH-25-14	78 1/2"	92 1/2"	40"



soho panel bed - walnut

		w	l	h
queen	1-SOH-22-04	66 1/2"	88 1/2"	40"
king	1-SOH-21-04	82 1/2"	88 1/2"	40"
cal king	1-SOH-25-04	78 1/2"	92 1/2"	40"

1 drawer



2-SOH-10-82
18 1/2" x 18" x 23 1/2"H

nightstand



2-SOH-15-82
20" x 20" x 17"H

wall mirror



5-CAL-20-04
30"W x 28 3/4"H x 1 1/4"Deep

6 drawer dresser



2-SOH-60-82
66 1/8" x 18" x 34 5/8"H

3 drawer



2-SOH-30-82
33 1/2" x 18" x 34 5/8"H

4 drawer



2-SOH-40-82
33 1/2" x 18" x 40 3/4"H

3 drawer + tv organizer



2-SOH-35-82
33 1/2" x 18" x 40 3/4"H

5 drawer



2-SOH-50-82
26 7/8" x 18" x 54 3/4"H



walnut base
walnut case
walnut drawers (80)



walnut base
walnut case
maple drawers (82)



walnut base
walnut case
cherry drawers (83)



walnut base
maple case
walnut drawers (84)



walnut base
cherry case
walnut drawers (85)



walnut base
maple case
maple drawers (86)



walnut base
cherry case
cherry drawers (87)



DINING



audrey dining in cherry

The double 'X' formation of the Audrey Dining Table trestle creates a state of dynamic tension giving the design a rigid base that provides diners with plenty of unobstructed leg room. Tables and Buffets are available in a number of sizes and configurations to meet the needs of almost any dining space.

All pieces are made of solid cherry hardwood and Made to Order in six finishes* with a variety of knob or pull options.

*Natural variations in solid wood and hand-applied finishes make each piece unique. Slight grain and irregularities as well as subtle differences in stain shades are signs that the furniture has been crafted from solid wood and are considered hallmarks of quality.



Scan here to view

eas. stow

extension and leaf storage.



extension tables

Extension tables incorporate self equalizing, ball bearing extension glides and a single 24" self storing butterfly leaf for single handed operation.

extension table



- 6-AUD-20-03 42" x 72"/96" x 30"H
- 6-AUD-22-03 42" x 66"/90" x 30"H
- 6-AUD-21-03 38" x 72"/96" x 30"H
- 6-AUD-24-03 38" x 66"/90" x 30"H
- 6-AUD-23-03 38" x 60"/84" x 30"H



fixed-top tables

40" x 72" table



- 6-AUD-10-03
40" x 72" x 30"H

40" x 60" table



- 6-AUD-06-03
40" x 60" x 30"H

benches & dining chairs

ingrid armchair - upholstered seat



8-ING-22-03
21 1/2" x 22" x 37 1/2"H

ingrid sidechair - upholstered seat



8-ING-20-03
19 3/4" x 22" x 37 1/2"H

estelle chair



8-EST-50-03
19 3/4" x 20" x 33 3/4"H

60" or 72" bench



8-AUD-06-03
60" x 17 3/4" x 17 1/2"H

8-AUD-10-03
72" x 17 3/4" x 17 1/2"H

ingrid armchair - wood seat



8-ING-23-03
21 1/2" x 22" x 37 1/2"H

ingrid sidechair - wood seat



8-ING-21-03
19 3/4" x 22" x 37 1/2"H

morgan armchair



8-MOR-32-03
21 1/2" x 22" x 37 1/2"H

morgan sidechair



8-MOR-30-03
19 3/4" x 22" x 37 1/2"H

upholstery options

Upholstered items are available in a range of microsuede, fabric or leather colors as well as COM (customer's own material). Please refer to the upholstery page of this catalog.

buffets and hutch

Buffets are available in four configurations to serve a wide range of storage needs. Hutch incorporates adjustable/removable shelves for wine bottle and stemware storage.

1 door on either side of 3 drawers buffet

6-AUD-50-03
66 1/8" x 18" x 33"H

hutch

6-CAL-75-03
60" x 12" x 16"H



The silverware drawer is fitted with an anti-tarnish insert.

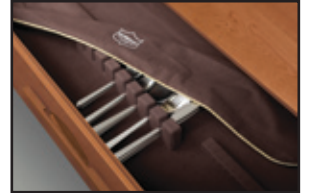

3 drawers on left, 2 doors on right buffet



6-AUD-52-03
66 1/8" x 18" x 33 7/8"H

3 drawers on right, 2 doors on left buffet



6-AUD-51-03
66 1/8" x 18" x 33 7/8"H

4 door buffet



6-AUD-40-03
66 1/8" x 18" x 33 7/8"H



audrey dining in walnut

The double 'X' formation of the Audrey Dining Table trestle creates a state of dynamic tension giving the design a rigid base that provides diners with plenty of unobstructed leg room. Tables and Buffets are available in a number of sizes and configurations to meet the needs of almost any dining space.

The Audrey Dining Room is crafted in solid American black walnut hardwood with natural finish. Audrey Dining items are finished with a low sheen (10 sheen) top coat.



Scan here to view

easystow

extension and leaf storage.

extension tables

Extension tables incorporate self equalizing, ball bearing extension glides and a single 24" self storing butterfly leaf for single handed operation.

extension table



- 6-AUD-20-04 42" x 72"/96" x 30"H
- 6-AUD-22-04 42" x 66"/90" x 30"H
- 6-AUD-21-04 38" x 72"/96" x 30"H
- 6-AUD-24-04 38" x 66"/90" x 30"H
- 6-AUD-23-04 38" x 60"/84" x 30"H



fixed-top tables

40" x 72" table



- 6-AUD-10-04
40" x 72" x 30"H

40" x 60" table



- 6-AUD-06-04
40" x 60" x 30"H

benches & dining chairs

ingrid armchair - upholstered seat



8-ING-22-04
21 1/2" x 22" x 37 1/2"H

ingrid sidechair - upholstered seat



8-ING-20-04
19 3/4" x 22" x 37 1/2"H

estelle chair



8-EST-50-04
19 3/4" x 20" x 33 3/4"H

60" or 72" bench



8-AUD-06-04
60" x 17 3/4" x 17 1/2"H

8-AUD-10-04
72" x 17 3/4" x 17 1/2"H

ingrid armchair - wood seat



8-ING-23-04
21 1/2" x 22" x 37 1/2"H

ingrid sidechair - wood seat



8-ING-21-04
19 3/4" x 22" x 37 1/2"H

morgan armchair



8-MOR-32-04
21 1/2" x 22" x 37 1/2"H

morgan sidechair



8-MOR-30-04
19 3/4" x 22" x 37 1/2"H

upholstery options

Upholstered items are available in a range of microsuede, fabric or leather colors as well as COM (customer's own material). Please refer to the upholstery page of this catalog.

buffets and hutch

Buffets are available in four configurations to serve a wide range of storage needs. Hutch incorporates adjustable/removable shelves for wine bottle and stemware storage.

1 door on either side of 3 drawers buffet

6-AUD-50-04
66 1/8" x 18" x 33"H

hutch

6-CAL-75-04
60" x 12" x 16"H



The silverware drawer is fitted with an anti-tarnish insert.

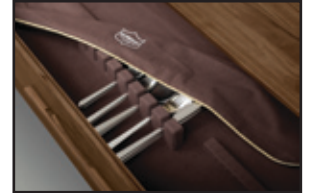

3 drawers on left, 2 doors on right buffet



6-AUD-52-04
66 1/8" x 18" x 33 7/8"H

3 drawers on right, 2 doors on left buffet



6-AUD-51-04
66 1/8" x 18" x 33 7/8"H

4 door buffet



6-AUD-40-04
66 1/8" x 18" x 33 7/8"H



catalina dining in cherry

Combining the clean, unadorned lines of the International Modernists with organic and geometric forms, the Catalina Collection is suggestive of the works of America's Mid-Century Modern designers. The years following WWII were a time of uncertainty but also of great hope and progress. Designs of the period reflected that sense of hope and the promise of an ideal future. In our current period, one finds comfort and nostalgia in Catalina's retro-modern shapes and sensibilities.

The Catalina Dining Room is crafted in solid cherry hardwood and Made to Order in six finishes* with a variety of knob or pull options. Catalina Dining items are finished with a low sheen (10 sheen) top coat.

*Natural variations in solid wood and hand-applied finishes make each piece unique. Slight grain and irregularities as well as subtle differences in stain shades are signs that the furniture has been crafted from solid wood and are considered hallmarks of quality.



Scan here to view

easystow

extension and leaf storage.



natural cherry (03)

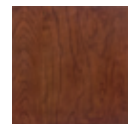

windsor cherry (13)



autumn cherry (23)

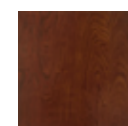

cognac cherry (33)



saddle cherry (43)

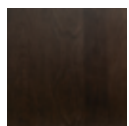

smoke cherry (53)

extension tables

Extension tables incorporate self equalizing, ball bearing extension glides and a single 24" self storing butterfly leaf for single handed operation.

four leg extension table



- 6-CAL-20-03 46" x 72"/96" x 30"H
- 6-CAL-21-03 46" x 66"/90" x 30"H
- 6-CAL-22-03 40" x 72"/96" x 30"H
- 6-CAL-24-03 40" x 66"/90" x 30"H
- 6-CAL-23-03 40" x 60"/84" x 30"H

trestle extension table



- 6-CAL-19-03 46" x 72"/96" x 30"H
- 6-CAL-18-03 46" x 66"/90" x 30"H
- 6-CAL-17-03 40" x 72"/96" x 30"H
- 6-CAL-16-03 40" x 66"/90" x 30"H
- 6-CAL-15-03 40" x 60"/84" x 30"H



round table extension table



- 6-CRE-48-03 48" x 48"/72" x 30"H
- 6-CRE-54-03 54" x 54"/78" x 30"H
- 6-CRE-60-03 60" x 60"/84" x 30"H

fixed-top tables

40" square table



- 6-CAL-05-03
40" x 40" x 30"H

40" x 60" table



- 6-CAL-06-03
40" x 60" x 30"H

40" x 78" table



- 6-CAL-10-03
40" x 78" x 30"H

dining chairs

estelle chair



8-EST-50-03
19 3/4" x 20" x 33 3/4"H

upholstery options

Upholstered items are available in a range of microsuede, fabric or leather colors as well as COM (customer's own material). Please refer to the upholstery page of this catalog.

ingrid armchair - upholstered seat



8-ING-22-03
21 1/2" x 22" x 37 1/2"H

ingrid sidechair - upholstered seat



8-ING-20-03
19 3/4" x 22" x 37 1/2"H

ingrid armchair - wood seat



8-ING-23-03
21 1/2" x 22" x 37 1/2"H

ingrid sidechair - wood seat



8-ING-21-03
19 3/4" x 22" x 37 1/2"H

morgan armchair



8-MOR-32-03
21 1/2" x 22" x 37 1/2"H

morgan sidechair



8-MOR-30-03
19 3/4" x 22" x 37 1/2"H

buffets and hutch

Buffets are available in nine configurations to serve a wide range of storage needs. Hutch incorporates adjustable/removable shelves for wine bottle and stemware storage.

The silverware drawer is fitted with an anti-tarnish insert.

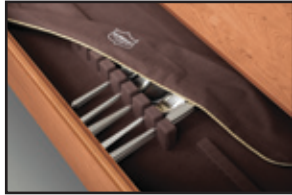

2 drawers over 4 door buffet

6-CAL-60-03
66 1/8" x 18" x 36"H

hutch

6-CAL-75-03
60" x 12" x 16"H

3 drawers on left, 2 doors on right buffet



6-CAL-52-03
66 1/8" x 18" x 29 7/8"H

3 drawers on right, 2 doors on left buffet



6-CAL-51-03
66 1/8" x 18" x 29 7/8"H

4 door buffet



6-CAL-40-03
66 1/8" x 18" x 29 7/8"H

1 door on either side of 3 drawers buffet



6-CAL-50-03
66 1/8" x 18" x 29 7/8"H

2 door buffet



6-CAL-25-03
33 1/2" x 18" x 29 7/8"H

4 drawers on left, 1 drawer over 2 doors on right buffet



6-CAL-72-03
66 1/8" x 18" x 36"H

4 drawers on right, 1 drawer over 2 doors on left buffet



6-CAL-71-03
66 1/8" x 18" x 36"H

1 drawer over 2 door buffet



6-CAL-30-03
33 1/2" x 18" x 36"H



catalina dining in walnut

Combining the clean, unadorned lines of the International Modernists with organic and geometric forms, the Catalina Collection is suggestive of the works of America's Mid-Century Modern designers. The years following WWII were a time of uncertainty but also of great hope and progress. Designs of the period reflected that sense of hope and the promise of an ideal future. In our current period, one finds comfort and nostalgia in Catalina's retro-modern shapes and sensibilities.

The Catalina Dining Room is crafted in solid American black walnut hardwood with natural finish and Made to Order with a variety of knob or pull options. Catalina Dining items are finished with a low sheen (10 sheen) top coat.



Scan here to view

easystow

extension and leaf storage.

extension tables

Extension tables incorporate self equalizing, ball bearing extension glides and a single 24" self storing butterfly leaf for single handed operation.

four leg extension table



- 6-CAL-20-04 46" x 72"/96" x 30"H
- 6-CAL-21-04 46" x 66"/90" x 30"H
- 6-CAL-22-04 40" x 72"/96" x 30"H
- 6-CAL-24-04 40" x 66"/90" x 30"H
- 6-CAL-23-04 40" x 60"/84" x 30"H

trestle extension table



- 6-CAL-19-04 46" x 72"/96" x 30"H
- 6-CAL-18-04 46" x 66"/90" x 30"H
- 6-CAL-17-04 40" x 72"/96" x 30"H
- 6-CAL-16-04 40" x 66"/90" x 30"H
- 6-CAL-15-04 40" x 60"/84" x 30"H



round table extension table



6-CRE-48-04 48" x 48"/72" x 30"H
6-CRE-54-04 54" x 54"/78" x 30"H
6-CRE-60-04 60" x 60"/84" x 30"H

fixed-top tables

40" square table



6-CAL-05-04
40" x 40" x 30"H

40" x 60" table



6-CAL-06-04
40" x 60" x 30"H

40" x 78" table



6-CAL-10-04
40" x 78" x 30"H

dining chairs

estelle chair



8-EST-50-04
19 3/4" x 20" x 33 3/4"H

upholstery options

Upholstered items are available in a range of microsuede, fabric or leather colors as well as COM (customer's own material). Please refer to the upholstery page of this catalog.

ingrid armchair - upholstered seat



8-ING-22-04
21 1/2" x 22" x 37 1/2"H

ingrid sidechair - upholstered seat



8-ING-20-04
19 3/4" x 22" x 37 1/2"H

ingrid armchair - wood seat



8-ING-23-04
21 1/2" x 22" x 37 1/2"H

ingrid sidechair - wood seat



8-ING-21-04
19 3/4" x 22" x 37 1/2"H

morgan armchair



8-MOR-32-04
21 1/2" x 22" x 37 1/2"H

morgan sidechair



8-MOR-30-04
19 3/4" x 22" x 37 1/2"H

buffets and hutch

Buffets are available in nine configurations to serve a wide range of storage needs. Hutch incorporates adjustable/removable shelves for wine bottle and stemware storage.

The silverware drawer is fitted with an anti-tarnish insert.



2 drawers over 4 door buffet

6-CAL-60-04
66 1/8" x 18" x 36"H

hutch

6-CAL-75-04
60" x 12" x 16"H

3 drawers on left, 2 doors on right buffet



6-CAL-52-04
66 1/8" x 18" x 29 7/8"H

3 drawers on right, 2 doors on left buffet



6-CAL-51-04
66 1/8" x 18" x 29 7/8"H

4 door buffet



6-CAL-40-04
66 1/8" x 18" x 29 7/8"H

1 door on either side of 3 drawers buffet



6-CAL-50-04
66 1/8" x 18" x 29 7/8"H

2 door buffet



6-CAL-25-04
33 1/2" x 18" x 29 7/8"H

4 drawers on left, 1 drawer over 2 doors on right buffet



6-CAL-72-04
66 1/8" x 18" x 36"H

4 drawers on right, 1 drawer over 2 doors on left buffet



6-CAL-71-04
66 1/8" x 18" x 36"H

1 drawer over 2 door buffet



6-CAL-30-04
33 1/2" x 18" x 36"H



kyoto dining

The aesthetic ideals common to traditional Japanese design and Western Modernism are on display in the Kyoto dining collection. Its broad surfaces and simple geometry give way to the naturally complex beauty of Kyoto's solid Walnut grain. Following the principle that we define our surroundings and our surroundings define us, qualities such as Simplicity, Asymmetry, Understatement and Naturalness come together in Kyoto to produce a design that subtly brings the mind to a state of tranquility or active-calm.

All pieces are crafted in solid American black walnut hardwood and are finished with a low sheen (10 sheen) top coat.

Upholstered items are available in a range of microsuede, fabric or leather colors as well as COM (customer's own material). Please refer to the upholstery page of this catalog for options.



Scan here to view

easystow

extension and leaf storage.

extension tables

Extension tables incorporate self equalizing, ball bearing extension glides and a single 24" self storing butterfly leaf for single handed operation.

extension table



6-KYO-20-04 36" x 72/96" x 30"H
6-KYO-21-04 36" x 60/84" x 30"H



fixed-top tables

36 x 72" table



6-KYO-04-04
36" x 72" x 30"H

36" x 60" table



6-KYO-03-04
36" x 60" x 30"H

dining chairs

kyoto armchair



8-KYO-42-04
21 1/4" x 22 1/2" x 33"H

kyoto sidechair



8-KYO-40-04
18 1/4" x 22 1/2" x 33"H

ingrid armchair - wood seat



8-ING-23-04
21 1/2" x 22" x 37 1/2"H

ingrid sidechair - wood seat



8-ING-21-04
19 3/4" x 22" x 37 1/2"H

ingrid armchair - upholstered seat



8-ING-22-04
21 1/2" x 22" x 37 1/2"H

ingrid sidechair - upholstered seat



8-ING-20-04
19 3/4" x 22" x 37 1/2"H

morgan armchair



8-MOR-32-04
21 1/2" x 22" x 37 1/2"H

morgan sidechair



8-MOR-30-04
19 3/4" x 22" x 37 1/2"H

estelle chair



8-EST-50-04
19 3/4" x 20" x 33 3/4"H

buffets and hutch

Buffets are available in nine configurations to serve a wide range of storage needs. Hutch incorporates adjustable/removable shelves for wine bottle and stemware storage.

The silverware drawer is fitted with an anti-tarnish insert.



2 drawers over 4 door buffet

6-KYO-60-04
66 1/8" x 18" x 37"H

hutch

6-CAL-75-04
60" x 12" x 16"H

3 drawers on left, 2 doors on right buffet



6-KYO-52-04
66 1/8" x 18" x 30 7/8"H

3 drawers on right, 2 doors on left buffet



6-KYO-51-04
66 1/8" x 18" x 30 7/8"H

4 door buffet



6-KYO-40-04
66 1/8" x 18" x 30 7/8"H

1 door on either side of 3 drawers buffet



6-KYO-50-04
66 1/8" x 18" x 30 7/8"H

2 door buffet



6-KYO-25-04
33 1/2" x 18" x 30 7/8"H

4 drawers on left, 1 drawer over 2 doors on right buffet



6-KYO-72-04
66 1/8" x 18" x 37"H

4 drawers on right, 1 drawer over 2 doors on left buffet



6-KYO-71-04
66 1/8" x 18" x 37"H

1 drawer over 2 door buffet



6-KYO-30-04
33 1/2" x 18" x 37"H



sarah dining

The Sarah Dining Room exhibits the clean lines and balanced proportions of its Shaker influence. All pieces are made of solid cherry hardwood and Made to Order in six finishes* with a variety of knob or pull options.

Upholstered items are available in a range of microsuede, fabric or leather colors as well as COM (customer's own material). Please refer to the upholstery page of this catalog for options.

*Natural variations in solid wood and hand-applied finishes make each piece unique. Slight grain and irregularities as well as subtle differences in stain shades are signs that the furniture has been crafted from solid wood and are considered hallmarks of quality.



Scan here to view
easystow
 extension and leaf storage.

extension tables

Extension tables incorporate self equalizing, ball bearing extension glides and a single 24" self storing butterfly leaf for single handed operation.

trestle extension table



- 6-SAR-20-03 42" x 72"/96" x 30"H
- 6-SAR-24-03 42" x 66"/90" x 30"H
- 6-SAR-23-03 38" x 72"/96" x 30"H
- 6-SAR-22-03 38" x 66"/90" x 30"H
- 6-SAR-21-03 38" x 60"/84" x 30"H

four leg extension table



- 6-SAR-25-03 42" x 72"/96" x 30"H
- 6-SAR-26-03 42" x 66"/90" x 30"H
- 6-SAR-28-03 38" x 72"/96" x 30"H
- 6-SAR-29-03 38" x 66"/90" x 30"H



fixed-top tables

36" x 48" table



6-SAR-02-03
36" x 48" x 30"H

36" square Table



6-SAR-01-03
36" x 36" x 30"H

40" square table



6-SAR-05-03
40" x 40" x 30"H

36" X 60" table



6-SAR-03-03
36" x 60" x 30"H

36" X 78" table



6-SAR-04-03
36" x 78" x 30"H

40" X 60" table



6-SAR-06-03
40" x 60" x 30"H

40" X 78" table



6-SAR-10-03
40" x 78" x 30"H

dining chairs

sarah armchair - upholstered seat



8-SAR-12-03
21 1/2" x 22" x 37 1/2"H

sarah sidechair - upholstered seat



8-SAR-10-03
19 3/4" x 22" x 37 1/2"H

upholstery options

Upholstered items are available in a range of microsuede, fabric or leather colors as well as COM (customer's own material). Please refer to the upholstery page of this catalog.

sarah armchair - wood seat



8-SAR-13-03
21 1/2" x 22" x 37 1/2"H

sarah sidechair - wood seat



8-SAR-11-03
19 3/4" x 22" x 37 1/2"H

ingrid armchair - upholstered seat



8-ING-22-03
21 1/2" x 22" x 37 1/2"H

ingrid sidechair - upholstered seat



8-ING-20-03
19 3/4" x 22" x 37 1/2"H

ingrid armchair - wood seat



8-ING-23-03
21 1/2" x 22" x 37 1/2"H

ingrid sidechair - wood seat



8-ING-21-03
19 3/4" x 22" x 37 1/2"H

morgan armchair



8-MOR-32-03
21 1/2" x 22" x 37 1/2"H

morgan sidechair



8-MOR-30-03
19 3/4" x 22" x 37 1/2"H

estelle chair



8-EST-50-03
19 3/4" x 20" x 33 3/4"H

buffets

Buffets are available in four configurations to serve a wide range of storage needs.

2 drawers over 4 door buffet



6-SAR-60-03
73 1/8" x 20 7/8" x 35 1/4"H

4 drawers on right, 1 drawer over 2 doors on left buffet



6-SAR-71-03
73 1/8" x 20 7/8" x 35 1/4"H

4 drawers on left, 1 drawer over 2 doors on right buffet



6-SAR-72-03
73 1/8" x 20 7/8" x 35 1/4"H

1 drawer over 2 door buffet



6-SAR-30-03
39 3/4" x 20 7/8" x 35 1/4"H

The silverware drawer is fitted with an anti-tarnish insert.





LIVING ROOM

berkeley occasional tables

A fusion of Arts & Crafts and Asian design, the Berkeley occasional tables are both sophisticated and practical. Crafted in solid cherry hardwood with American black walnut accents, the collection features a variety of tables with storage drawers. The Berkeley Tables are Made to Order in six finishes* (specify conventional or water borne finish) with a variety of pull options.

*Natural variations in solid wood and hand-applied finishes make each piece unique. Slight grain and irregularities as well as subtle differences in stain shades are signs that the furniture has been crafted from solid wood and are considered hallmarks of quality.



bench upholstery options

Upholstered items are available in a range of microsuede, fabric or leather colors as well as COM (customer's own material). Please refer to the upholstery page of this catalog.

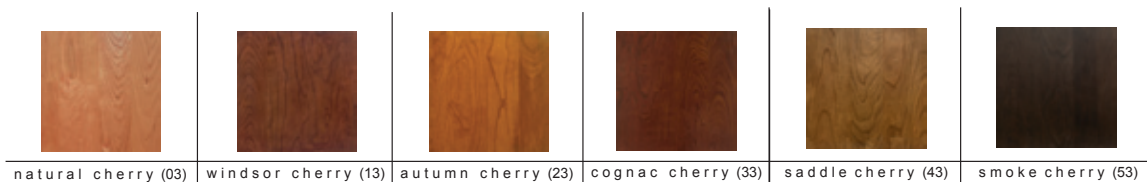

tv stand
bookcase

5-CAL-49-04 53" x 20" x 23"H
5-CAL-50-04 66" x 20" x 23"H
5-CAL-55-04 19 1/2" x 14" x 64"H

side table



5-CAL-30-04
24"R x 16 3/4"H

5-CAL-25-04
24"R x 13 3/4"H



wire management



oval coffee table



5-CAL-40-04
48" x 28" x 13 3/4"H

5-CAL-45-04
48" x 28" x 16 3/4"H

catalina media and occasionals

Catalina media and occasional pieces include a TV stand designed with wire management to organize your home entertainment equipment that is complemented by optional bookcases. The collection also includes a sofa table, coffee table, side table and end table.

The Catalina Media and Occasional pieces are crafted in solid American black walnut hardwood with natural finish (specify conventional or water borne finish) and Made to Order with a variety of knob or pull options.

end table



2-CAL-15-04
20" x 20" x 17 1/4"H

2-CAL-25-04
20" x 20" x 20 1/4"H

sofa table



5-CAL-60-04
52" x 18" x 30"H

3 drawer + tv organizer



2-CAL-35-04
33 1/2" x 18" x 36"H



fusion occasional tables

The Fusion occasional tables are an elegant display of the common ground unifying structure and aesthetic. Four legs, joined both at the table top and across the floor, coming together to create a perfectly rigid structure is what defines the Fusion occasional tables. Available as rectangular coffee tables as well as end tables, Fusion makes a compelling visual statement in any living room. The Fusion Tables are crafted in solid American black walnut hardwood and are finished with a low sheen (10 sheen) top coat.

end table



5-FUS-30-04
24" x 28" x 24"H

coffee table



5-FUS-42-04
48" x 24" x 18"H

sofa table



5-FUS-50-04
60" x 18" x 30"H



h a n c o c k o c c a s i o n a l t a b l e s

Hancock occasional tables are named after Boston's famous John Hancock Tower. Designed by Henry Cobb, the Hancock Tower is noted for the way its enormous mass seemingly disappears into the historic surroundings of Boston's Copley Plaza. Heavy framing members drawn to a soften knife edge and legs positioned against top edges produce a similar effect with our Hancock occasional tables allowing them to seamlessly blend into any decor.

The Hancock Tables are crafted in solid American black walnut hardwood and are finished with a low sheen (10 sheen) top coat.

rectangular coffee table



5-HAN-42-04
52" x 30" x 16"H

square coffee table



5-HAN-40-04
42" x 42" x 16"H

oval coffee table



5-HAN-36-04
48" x 32" x 16"H

end table



5-HAN-30-04
24" x 24" x 24"H

round coffee table



5-HAN-35-04
42" x 42" x 16"H



kyoto occasional tables

The aesthetic ideals common to traditional Japanese design and Western Modernism are on display in the Kyoto occasional table's collection. Its broad surfaces and simple geometry give way to the naturally complex beauty of Kyoto's solid Walnut grain. Following the principle that we define our surroundings and our surroundings define us, qualities such as Simplicity, Asymmetry, Understatement and Naturalness come together in Kyoto to produce a design that subtly brings the mind to a state of tranquility or active-calm. The Kyoto Tables are crafted in solid American black walnut hardwood and are finished with a low sheen (10 sheen) top coat.

rectangular coffee table



5-KYO-42-04
48" x 24" x 18"H

end table



5-KYO-30-04
24" x 24" x 24"H

sofa table



5-KYO-60-04
60" x 18" x 30"H

square coffee table



5-KYO-40-04
42" x 42" x 18"H

monterey occasional tables

The Monterey occasional tables give traditional Arts & Crafts an Asian touch. Subtly evoking the form of a traditional East Asian Pagoda, Monterey occasional tables provide both style and ample storage. All pieces are crafted in solid cherry hardwood and Made to Order in six finishes* (specify conventional or water borne finish).

*Natural variations in solid wood and hand-applied finishes make each piece unique. Slight grain and irregularities as well as subtle differences in stain shades are signs that the furniture has been crafted from solid wood and are considered hallmarks of quality.

48" x 30" coffee table



5-MNT-42-03
48" x 30" x 18"H

end table - left



2-BER-01-03
22" x 15 1/2" x 26"H

bench



5-BER-60-03
58" x 19" x 19"H

36" x 36" coffee table



5-MNT-40-03
36" x 36" x 18"H

end table - right



2-BER-02-03
22" x 15 1/2" x 26"H

sofa table



5-MNT-60-03
48" x 18" x 30"H

bench upholstery options

Upholstered items are available in a range of microsuede, fabric or leather colors as well as COM (customer's own material). Please refer to the upholstery page of this catalog.

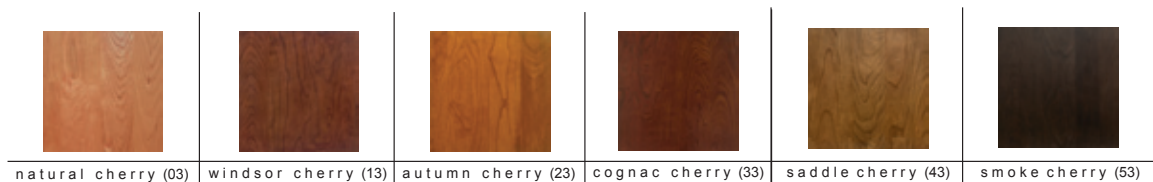

natural cherry (03)

windsor cherry (13)

autumn cherry (23)

cognac cherry (33)

saddle cherry (43)

smoke cherry (53)

unica tables by the inch

Unica tables by the inch is a highly versatile table series that can be ordered custom sized to meet your specific needs. The clean minimalist design, highlighted by a subtle metallic structural element, is timeless and melds with any décor. The program allows you to choose the width and length of your table in one inch increments as well as choose from one of five table heights. A highly functional series, Unica tables may be ordered as Coffee Tables, Benches, End Tables, Consol/Sofa Tables, Desks/Work Tables, Dining Tables, Counter height Tables.

The Unica Tables are crafted in solid American black walnut hardwood with natural finish or solid cherry hardwood in six finishes*. The tables in walnut are finished with a low sheen (10 sheen) top coat.

*Natural variations in solid wood and hand-applied finishes make each piece unique. Slight grain and irregularities as well as subtle differences in stain shades are signs that the furniture has been crafted from solid wood and are considered hallmarks of quality.



Unica's Flexible Function

1. **16" High Series** - appropriate for benches and low coffee tables (18" x 60" bench pictured)
2. **18" High Series** - appropriate for intermediate height coffee tables (24" x 48" coffee table pictured)
3. **24" High Series** - appropriate for end tables and counter height stools (18" x 18" end table pictured)
4. **30" High Series** - appropriate for sofa tables, dining tables and desks (40" x 70" dining table pictured)
5. **36" High Series** - appropriate for counter height tables and kitchen islands (36" x 36" counter height table pictured)



The brushed aluminum joining plate allows Unica legs to join directly with the top eliminating the need for bulky apron assemblies.

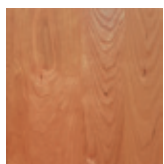

natural cherry (03)

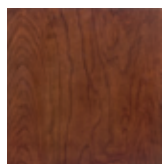

windsor cherry (13)



autumn cherry (23)

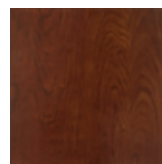

cognac cherry (33)



saddle cherry (43)

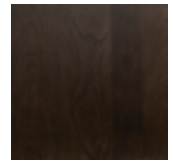

smoke cherry (53)

dining table and benches in natural walnut



40" x 70" x 30"H
18" x 60" x 16"H

coffee table in natural cherry



24" x 48" x 18"H

Unica table tops may be ordered in one inch increments with widths from 16" to 48" and lengths from 18" up to 84" In order to preserve proper grain orientation, specified width may not exceed length.

WIDTH IN INCHES - PRICES ADJUST IN 2" INCREMENTS Specify desired dimension to nearest inch	LENGTH IN INCHES - PRICES ADJUST IN 6" INCREMENTS											
	Specify desired dimension to nearest inch											
	18	24	30	36	42	48	54	60	66	72	78	84
16	✓	✓	✓	✓	✓	✓	✓	✓	✓	✓	✓	✓
18	✓	✓	✓	✓	✓	✓	✓	✓	✓	✓	✓	✓
20	NA	✓	✓	✓	✓	✓	✓	✓	✓	✓	✓	✓
22	NA	✓	✓	✓	✓	✓	✓	✓	✓	✓	✓	✓
24	NA	✓	✓	✓	✓	✓	✓	✓	✓	✓	✓	✓
26	NA	NA	✓	✓	✓	✓	✓	✓	✓	✓	✓	✓
28	NA	NA	✓	✓	✓	✓	✓	✓	✓	✓	✓	✓
30	NA	NA	✓	✓	✓	✓	✓	✓	✓	✓	✓	✓
32	NA	NA	NA	✓	✓	✓	✓	✓	✓	✓	✓	✓
34	NA	NA	NA	✓	✓	✓	✓	✓	✓	✓	✓	✓
36	NA	NA	NA	✓	✓	✓	✓	✓	✓	✓	✓	✓
38	NA	NA	NA	NA	✓	✓	✓	✓	✓	✓	✓	✓
40	NA	NA	NA	NA	✓	✓	✓	✓	✓	✓	✓	✓
42	NA	NA	NA	NA	✓	✓	✓	✓	✓	✓	✓	✓
44	NA	NA	NA	NA	NA	✓	✓	✓	✓	✓	✓	✓
46	NA	NA	NA	NA	NA	✓	✓	✓	✓	✓	✓	✓
48	NA	NA	NA	NA	NA	✓	✓	✓	✓	✓	✓	✓



HOME OFFICE



natural cherry (03)

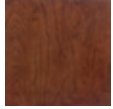

windsor cherry (13)



autumn cherry (23)

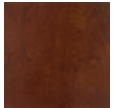

cognac cherry (33)

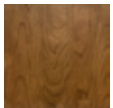

saddle cherry (43)

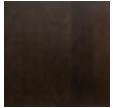

smoke cherry (53)

desk, return and desktop organizer

desk	3-BER-10-03	30" x 60" x 30"H
return	3-BER-20-03	24" x 60" x 30"H
desktop organizer	5-BER-32-03	48" x 11 1/4" x 8 3/4"H



berkeley home office

Traditional Japanese woodworkers saw design as the process of releasing wood's richness and natural beauty. Rather than self indulgent pursuit of personal tastes, these craftsmen had an aesthetic vision inseparably tied to the natural characteristics of the material itself. This philosophy is evident in the Berkeley Home Office. With its graceful curves and a form that allows for plenty of visible end grain, Berkeley highlights the depth of character inherent in its solid cherry and American black walnut construction.

The collection includes a desk and return along with file, and organizer options that can be combined to create a trim and functional workspace.

The Berkeley Home Office is crafted in solid cherry hardwood* and are Made to Order in six finishes** (specify conventional or water borne finish) with a variety of pull options.

*The lateral file and bookcase case sides are laminated with select cherry veneer.

**Natural variations in solid wood and hand-applied finishes make each piece unique. Slight grain and irregularities as well as subtle differences in stain shades are signs that the furniture has been crafted from solid wood and are considered hallmarks of quality.

rolling file



4-BER-35-03
19" x 22 3/8" x 25 1/2"H

secretary desk



3-BER-30-03
24" x 39" x 30"H

lateral file



4-BER-30-03
30 1/2" x 20" x 30"H

bookcases



4-BER-20/21/22-03
33 3/4" x 15 1/2" x 35 1/4"/61"/74 3/4"H



catalina home office

Catalina Home Office includes a sleek desk that is complemented by a selection of case pieces, including a credenza and organizer that offers generous storage and a laptop desk that creates a trim, functional workspace. File storage is offered with a cabinet that is equipped with anti-tip locks and can function as a printer stand.

The Catalina Home Office is crafted in solid American black walnut hardwood with natural finish (specify conventional or water borne finish) and Made to Order with a variety of knob or pull options.

24" x 48" desk



3-CAL-06-04
24" x 48" x 30"H

file



4-CAL-30-04
33 1/2" x 18" x 29 7/8"H

catalina narrow file



4-CAL-25-04
18 1/2" x 18" x 29 7/8"H

24" x 60" desk
30" x 60" desk



3-CAL-08-04 24" x 60" x 30"H
3-CAL-10-04 30" x 60" x 30"H

credenza and organizer



4-CAL-70-04 66 1/8" x 18" x 29 7/8"H
4-CAL-75-04 60" x 12" x 16" H

laptop desk



3-CAL-20-04
33 1/2" x 18" x 36"H

desk, return, desktop organizer and rolling desk

- 3-SAR-11-03 30" x 60" x 30"H desk
- 3-SAR-20-03 24" x 60" x 30"H return
- 5-SAR-32-03 49 1/2" x 12 1/2" x 8 3/4"H desktop organizer
- 4-SAR-35-03 20 1/2" x 22 1/2" x 25 1/2"H rolling file



sarah home office

The popular Sarah Home Office collection includes two desk options along with file, shelving, and organizer options that work together to create a trim, functional workspace. The Sarah desk, featuring a drawer-style keyboard tray, can be extended with a left or right side return. A separate desktop organizer adds storage space. A smaller secretary desk can be used alone or accompanied by a return. File storage is offered with a lateral or rolling cabinet; both are equipped with anti-tip locks and can function as a printer stand. Bookcases are available in three sizes and feature adjustable shelves. All pieces are available in solid cherry hardwood* and are Made to Order in six finishes** (specify conventional or water borne finish) with a variety of knob options.

*The Sarah lateral file and bookcase case sides are laminated with cherry veneer.
 **Natural variations in solid wood and hand-applied finishes make each piece unique. Slight grain and irregularities as well as subtle differences in stain shades are signs that the furniture has been crafted from solid wood and are considered hallmarks of quality.

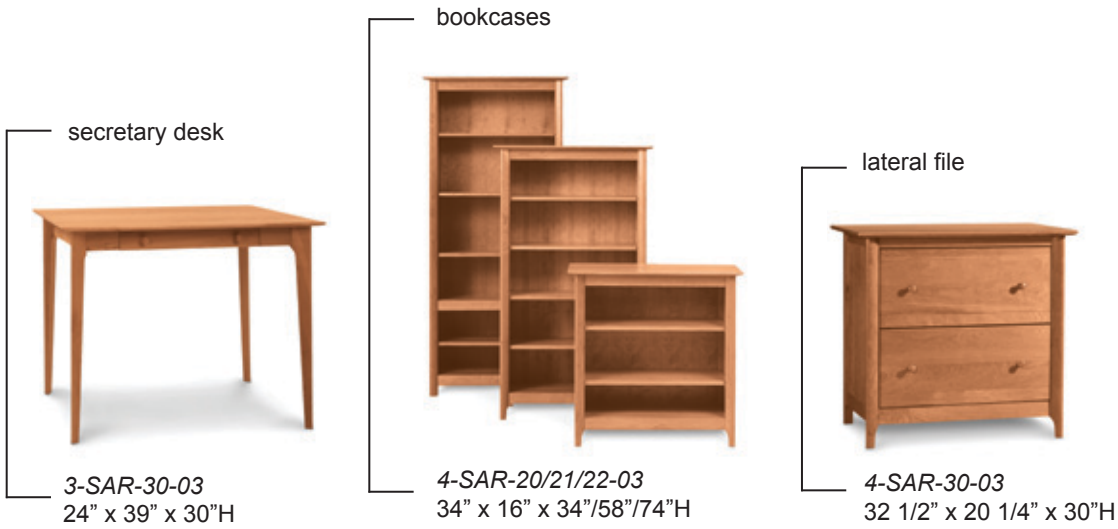

secretary desk

3-SAR-30-03
24" x 39" x 30"H

bookcases

4-SAR-20/21/22-03
34" x 16" x 34"/58"/74"H

lateral file

4-SAR-30-03
32 1/2" x 20 1/4" x 30"H

Select Hardwoods

Copeland selects hardwoods with a long history of sales performance in the North American marketplace. These well established species remain prized and continue to attract top dollar with consumers.



cherry

Cherry offers superior woodworking characteristics. A strong hardwood with a subtle grain pattern add a uniform texture, its color darkens with exposure to sunlight.



maple

Maple is a heavy wood characterized by straight grain or clusters of curls (burls). It is highly resistant to abrasion and indentation and the natural color ranges from cream to light brown.

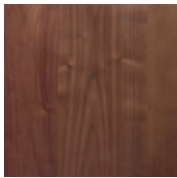

walnut

American Black Walnut is a dense wood with a uniform to highly figured grain. The color ranges from light gray-brown to dark purplish-brown. Its rich patina deepens with age.

Wood options are indicated in piece descriptions.

Finishes and Finish options

All pieces are finished with pre-catalyzed lacquer or water borne finish that resists stains, moisture rings and spots, heat damage (from hot beverages, etc.), and abrasions. Finishes are formulated to meet Kitchen Cabinet Manufacturers Association (KCMA) standards and provides lasting protection.

					
natural cherry (03)	windsor cherry (13)	autumn cherry (23)	cognac cherry (33)	saddle cherry (43)	smoke cherry (53)
					
natural maple (01)	cocoa maple (11)	dark chocolate maple (21)	slate maple (41)	white maple (51)	dark honey maple (61)
					
				chestnut maple (71)	black maple (81)

Natural variations in solid wood and hand-applied finishes make each piece unique. Slight grain and irregularities as well as subtle differences in stain shades are signs that the furniture has been crafted from solid wood and are considered hallmarks of quality



Knob and Pull options

A selection of knobs and pulls is available for all Copeland cabinetry and desks.

Upholstery Options

Upholstered items are available in a range of microsuede, fabric or leather color as well as COM (customer's own material)

grade A-microsuede

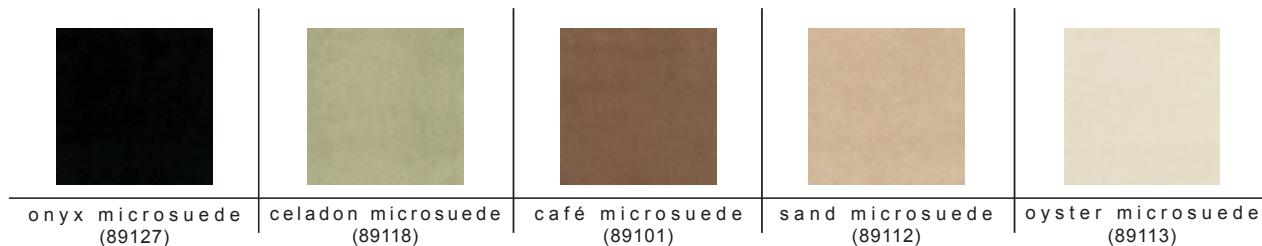

grade B-fabric

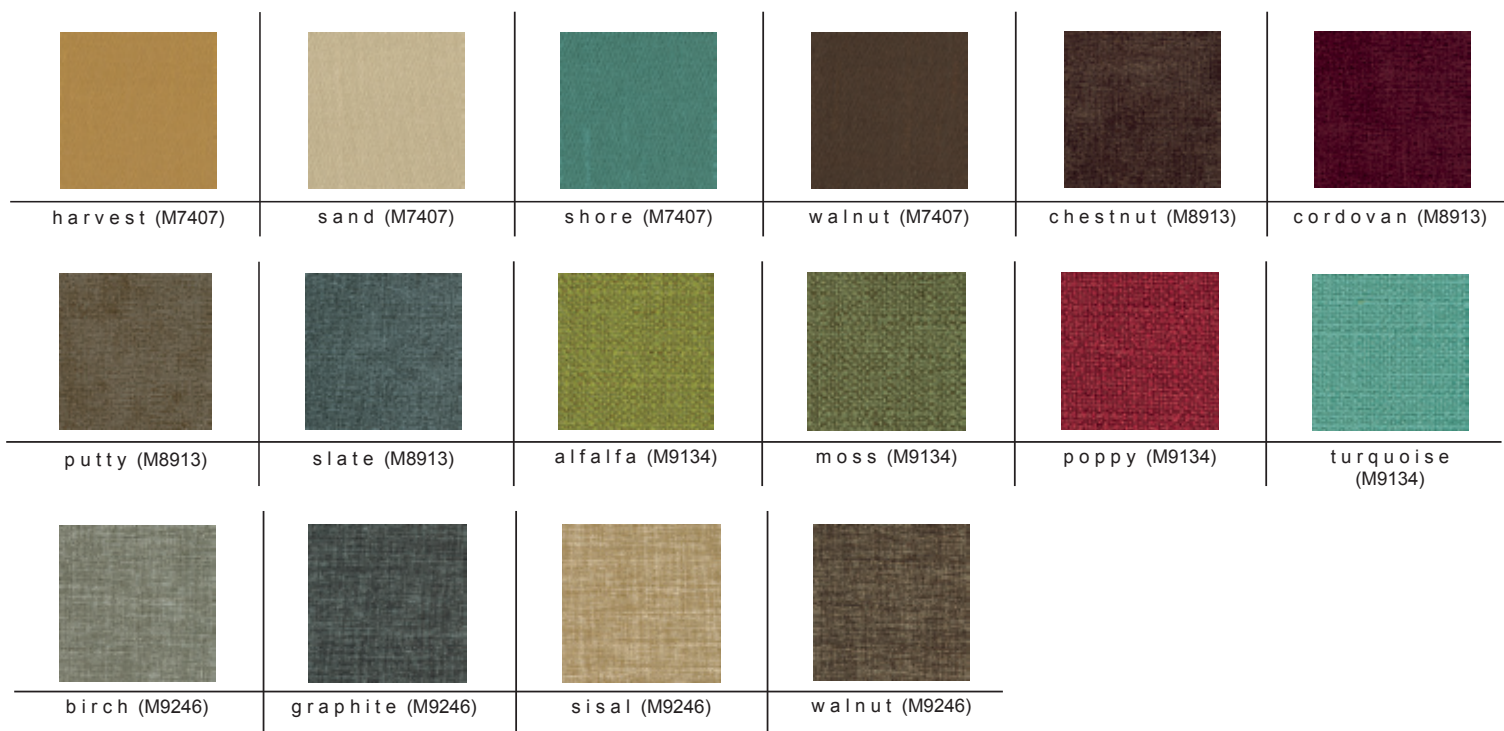

leather



Green Furniture

Copeland Furniture is Green Furniture

Preservation and stewardship are values that run deep in Vermont. We take pride in the quality of the environment and the natural beauty that surrounds us. Here are some of the ways that our environmental values are reflected in each piece of furniture that we make:

We use sustainably harvested hardwoods from the American Northern Forest

The lumber we use comes from within 500 miles of our factory. Living and working in and near the regions that supply our raw materials means that far less fossil fuel is consumed and less carbon dioxide emitted through transportation. Furthermore, a recent independent research study,* commissioned by the American Hardwood Export Council (AHEC) and conducted by a team of international experts confirms that:

- U.S. hardwoods derive from legal and well managed forests. Hardwood procured from anywhere in the hardwood states could be considered Low Risk in all five Forest Stewardship Council (FSC) controlled wood risk categories.
- There exists, a low risk that U.S. hardwoods are produced from controversial sources as defined in the Chain of Custody standard of the Program for the Endorsement of Forest Certification (PEFC).
- The U.S. hardwood-producing region can be considered low risk for illegal and non-sustainable hardwood sourcing as a result of public and private regulatory and non-regulatory programs.

**The full report can be found at www.ahec-europe.org*



We were awarded Silver Exemplary Membership Status by Sustainable Furnishings Council

Copeland Furniture was awarded Silver Exemplary Membership Status by Sustainable Furnishings Council (SFC), joining only a handful of companies to have been awarded this prestigious distinction for proven performance in meeting a range of specific sustainability measures.



Recipient of the Sage Award for environmental excellence

Sponsored by the American Home Furnishings Alliance (AHFA), the award program was launched to recognize environmental accomplishments within the home furnishings industry. For more information go to www.sageaward.org

Water based finishes are optional on most our furniture.

A water born, formaldehyde free finish may be specified for most Copeland Furniture pieces. These finishes are every bit as durable as our traditional catalyzed lacquer with the added benefit of drastically reduced VOC emissions at the factory and off-gassing at the home.

We create durable furniture with timeless designs that will last generations.

Heirloom-quality furniture has less environmental impact than a piece that will fail or has a "fashion life." We use time-tested joinery and construction methods, combined with durable finishes and quality hardware.

We're not done.

While the environmental impact of our factory and the environmental cost of the furniture we build for you is among the lowest, we're not standing still. We've continued to work to reduce VOC (volatile organic compounds) emissions. We've reduced packaging material purchases with the installation of a box making machine that allows us to make only what we need. We recycle all packaging waste and have reduced our reliance on landfill disposal. We now heat our building completely with wood waste from our manufacturing operation further reducing our consumption of imported oil.

For more information and greater detail, please visit www.copelandfurniture.com





copeland
FURNITURE

copelandfurniture.com